

SIEMENS

SIMATIC

Text Display (TD) User Manual

Preface, Contents

Product Overview **1**

Installing Your TD Device **2**

Using the Keypad Designer to
Create a Custom Faceplate for
Your TD Device **3**

Using the Text Display Wizard to
Configure the S7-200 CPU for
Your TD Device **4**

Operating Your TD Device **5**

Appendices

Technical Specifications and
Reference Information **A**

Connecting Multiple Devices on a
Network **B**

Troubleshooting **C**

Index

Safety Guidelines

This manual contains notices which you should observe to ensure your own personal safety, as well as to protect the product and connected equipment. These notices are highlighted in the manual by a warning triangle and are marked as follows according to the level of danger:



Danger

Danger indicates an imminently hazardous situation which, if not avoided, will result in death or serious injury.



Warning

Warning indicates a potentially hazardous situation which, if not avoided, could result in death or serious injury.



Caution

Caution used with the safety alert symbol indicates a potentially hazardous situation which, if not avoided, may result in minor or moderate injury.

Caution

Caution used without the safety alert symbol indicates a potentially hazardous situation which, if not avoided, may result in property damage.

Notice

Notice indicates a potential situation which, if not avoided, may result in an undesirable result or state.

Qualified Personnel

Only **qualified personnel** should be allowed to install and work on this equipment. Qualified persons are defined as persons who are authorized to commission, to ground, and to tag circuits, equipment, and systems in accordance with established safety practices and standards.

Correct Usage

Note the following:



Warning

This device and its components may only be used for the applications described in the catalog or the technical descriptions, and only in connection with devices or components from other manufacturers which have been approved or recommended by Siemens.

This product can only function correctly and safely if it is transported, stored, set up, and installed correctly, and operated and maintained as recommended.

Trademarks

SIMATIC®, SIMATIC HMI® and SIMATIC NET® are registered trademarks of SIEMENS AG.

Some of the other designations used in these documents are also registered trademarks; the owner's rights may be violated if they are used by third parties for their own purposes.

Copyright Siemens AG 2005 All rights reserved

The reproduction, transmission or use of this document or its contents is not permitted without express written authority. Offenders will be liable for damages. All rights, including rights created by patent grant or registration of a utility model or design, are reserved.

Siemens AG
Bereich Automation and Drives
Geschäftsgebiet Industrial Automation Systems
Postfach 4848, D- 90327 Nuernberg

Disclaimer of Liability

We have checked the contents of this manual for agreement with the hardware and software described. Since deviations cannot be precluded entirely, we cannot guarantee full agreement. However, the data in this manual are reviewed regularly and any necessary corrections included in subsequent editions. Suggestions for improvement are welcomed.

© Siemens AG 2005
Technical data subject to change.

Preface

Purpose of the manual

The *SIMATIC Text Display (TD) User Manual* is a combination user and reference manual that describes the operation of the TD devices (TD 100C, TD 200C and TD 200) with an S7-200 CPU.

Required Basic Knowledge

This manual is designed for engineers, programmers, and maintenance personnel who have a general knowledge of programmable logic controllers and operator interfaces.

Scope of This Manual

This manual describes the installation, configuration and operation of the TD 100C version 1.0, the TD 200 version 3.0, and the TD 200C version 1.0. This manual also describes the Text Display wizard of STEP 7-Micro/WIN (used to configure the S7-200 CPU for the TD devices) and the Keypad Designer application (used to configure the keypad of the TD 100C and the TD 200C).

To utilize these TD devices, you must use the following:

- STEP 7-Micro/WIN version 4.0 SP2 or greater for TD 100C version 1.0
- STEP 7-Micro/WIN version 4.0 or greater for TD 200C version 1.0 and TD 200 version 3.0

Agency Approvals

These SIMATIC TD devices meet the standards and regulations of the following agencies.

- Underwriters Laboratories, Inc.(UL): UL 60950 for the TD 200C and TD 200, and UL 508, UL 1604 for the TD 100C
- Canadian Standards Association: CSA C22.2 No. 60950 standard for the TD 200C and TD 200, and CS22.2 No. 142 standard and CSA-213 for the TD 100C

Refer to Appendix A for additional compliance information.

Certification

These SIMATIC TD devices have the following certification:

- Underwriters Laboratories (UL) Standards
TD 200C, TD 200: UL 60950 and CSA C22.2 No. 60950
TD 100C: UL 508 and CS22.2 No. 142; UL 1604 and CSA-213
- Factory Mutual Research: Standard Class Number 3611, Class I, Division 2, Group A, B, C, D, and Class I, Zone 2, Group IIC.

Temperature class T5 is adhered to when the ambient temperature during operation does not exceed 60°C.

CE Labeling

These SIMATIC TD devices fulfill the requirements and protection guidelines of the following EU directives:

- EC Directive 94/9/EC "ATEX directive" (TD 200 and TD 200C only)
- EC Directive 89/336/EEC "EMC directive"

C-Tick

These TD devices are compliant with requirements of the AS/NZS CISPR22 standard.

Recycling and Disposal

Please contact a company certified in the disposal of electronic scrap for environmentally safe recycling and disposal of your device.

Place of this Document in the Information Environment

Product Family	Documentation	Order Number
S7-200	SIMATIC Text Display (TD) User Manual (resides on the STEP 7-Micro/WIN documentation CD)	Not applicable
	Simplified Chinese Character Set (resides on the STEP 7-Micro/WIN documentation CD)	Not applicable
S7-200	S7-200 Programmable Controller System Manual	6ES7 298-8FA24-8BH0

Finding Your Way

If you are a first-time (novice) user of TD devices, you should read the entire *SIMATIC Text Display (TD) User Manual*. If you are an experienced user, refer to the table of contents or index to find specific information.

The *SIMATIC Text Display User Manual* is organized according to the following topics:

- Chapter 1 (Product Overview) provides an overview of the TD devices
- Chapter 2 (Installing Your TD Device) provides installation instructions and guidelines.
- Chapter 3 (Using the Keypad Designer to Create a Custom Faceplate for Your TD Device) provides information about the Keypad Designer and the steps required for configuring the keypad and faceplate for the TD 100C and the TD 200C.
- Chapter 4 (Using the Text Display Wizard to Configure the S7-200 CPU for Your TD Device) provides information about using the Text Display wizard of STEP 7-Micro/WIN to configure the S7-200 CPU for the TD device.
- Chapter 5 (Operating Your TD Device) provides information about the basic operation of the TD devices and also describes the features and capabilities.
- Appendix A (Technical Specifications and Reference Information) provides the technical information for the TD devices and also provides references for the character sets supported.
- Appendix B (Connecting Multiple Devices on a Network) provides information about using a TD device in a network with other TD devices and S7-200 CPUs.
- Appendix C (Troubleshooting) provides information to help you diagnose problems with the TD device.

The *Simplified Chinese Character Set* shows the characters supported by the TD devices. This file is an electronic file and resides on the STEP 7-Micro/WIN documentation CD.

Additional Support

Local Siemens Sales Office or Distributor

For assistance in answering any technical questions, for training on the S7-200 products, or for ordering S7-200 products, contact your Siemens distributor or sales office. Because your sales representatives are technically trained and have the most specific knowledge about your operations, process and industry, as well as about the individual Siemens products that you are using, they can provide the fastest and most efficient answers to any problems that you might encounter.

Service & Support on the Internet

In addition to our documentation, we offer our Know-How online on the internet at:

<http://www.siemens.com/automation/service&support>

where you will find the following:

- Access the S7-200 Internet site to find additional S7-200 product information:
www.siemens.com/S7-200
This site includes frequently asked questions (FAQs), Programming Tips (application examples and sample programs), information about newly released products, and product updates or downloads
- Read the newsletter, which constantly provides you with up-to-date information on your products
- Use the Search feature of the Service & Support area to find specific documentation
- Share information and exchange experiences with a forum of other users and experts from all over the world
- Find your local Siemens representative for Automation & Drives
- Use the "Services" link to find information on field service, repairs, spare parts and more

Technical Services

The highly trained staff of the S7-200 Technical Services center is also available to help you solve any problems that you might encounter. You can call on them 24 hours a day, 7 days a week.

A&D Technical Support

Worldwide, available 24 hours a day:



<p>Worldwide (Nuremberg) Technical Support</p> <p>24 hours a day, 365 days a year Phone: +49 (180) 5050-222 Fax: +49 (180) 5050-223 E-Mail: adsupport@siemens.com GMT: +1:00</p>	<p>United States (Johnson City) Technical Support and Authorization</p> <p>Local time: Mon.-Fri. 8:00 AM to 5:00 PM Phone: +1 (423) 262 2522 +1 (800) 333-7421 (USA only) Fax: +1 (423) 262 2289 E-Mail: simatic.hotline@sea.siemens.com GMT: -5:00</p>	<p>Asia / Australia (Beijing) Technical Support and Authorization</p> <p>Local time: Mon.-Fri. 8:00 AM to 5:00 PM Phone: +86 10 64 75 75 75 Fax: +86 10 64 74 74 74 E-Mail: adsupport.asia@siemens.com GMT: +8:00</p>
<p>Europe / Africa (Nuremberg) Authorization</p> <p>Local time: Mon.-Fri. 8:00 AM to 5:00 PM Phone: +49 (180) 5050-222 Fax: +49 (180) 5050-223 E-Mail: adsupport@siemens.com GMT: +1:00</p>		
<p>The languages of the SIMATIC hotlines and the authorization hotline are generally German and English.</p>		

Contents

1	Product Overview	1
	Introducing the S7-200 Text Display (TD) Devices	2
	Features of the TD Devices	3
	International Languages and Characters Support	4
	Comparing the TD 100C, the TD 200 and the TD 200C	5
	Using the TD Device to Access Screens and Alarms	6
	Dividing Information into Screens and Bit-Enabled Alarms	7
	Installation and Configuration Tasks	9
	Creating a Custom Faceplate for The TD Device	12
	Printing the Custom Faceplate for the TD Device	13
	Printer Requirements	13
	Ordering Additional Faceplate Material	13
2	Installing Your TD Device	15
	Components Shipped with the TD Devices	16
	Mounting the TD 200C and TD 200 in a Panel or on a Surface	17
	Preparing the Mounting Surface for a TD 200C or TD 200	17
	Preparing the TD 200C and TD 200 for Mounting	17
	Positioning the Spacers for the TD 200C and TD 200	17
	Mounting the TD 200C and TD 200	18
	Mounting the TD 100C in a Panel or on a Surface	18
	Preparing the Mounting Surface for a TD 100C	18
	Mounting the TD 100C	18
	Customizing the Labels for the Keys of the TD 200	19
	Modifying the Label Insert of the TD 200	19
	Creating a Custom Label Insert for the TD 200	19
	Installing a Faceplate for the TD 100C and the TD 200C	20
	Connecting the TD/CPU Cable	21
	Supplying Power for the TD Device	22
	Establishing a Connection for Your TD Device	23
	TD 100C and TD 200C	23
3	Using the Keypad Designer to Create a Custom Faceplate for Your TD Device	25
	Using the Keypad Designer with Other Applications	26
	Starting the Keypad Designer	28
	Adding Buttons to the Keypad	29
	Inserting a Button	29
	Modifying the Shape of a Button	29
	Defining the Properties of the Button	30
	Exporting the Keypad Layout to a Graphics Application	32
	Adding a Panel Image to the Faceplate	33
	Importing a Panel Image	33

Saving the Keypad to a TD Configuration File	34
Reversing the Panel Image	34
Printing the Panel Image on a Faceplate	35
Printing a Single Faceplate from the Keypad Designer	36
Printing the Faceplate from a Word-Processing Application	37
Installing the Printed Faceplate onto the TD device	38
4 Using the Text Display Wizard to Configure the S7-200 CPU for Your TD Device	39
Overview of the Configuration Tasks	40
Configuring the TD Device	42
Task Overview	42
Starting the Text Display Wizard for the TD Device	43
Selecting the Type of TD Device to Configure	43
Selecting a Password for the TD Device	44
Enabling the TD Menu Functions	44
Selecting the Update Rate for the TD Device	46
Selecting the Language and the Character Set	46
Selecting the Font Size (TD 100C only)	47
Loading a Custom Keypad (TD 100C and TD 200C Only)	47
Configuring the Buttons on the Keypad	48
Configuring the Screens for the TD Device	49
Creating the User Menu	50
Creating the Text for a Screen	51
Embedding a Variable into the Text of a Screen	51
Configuring the Alarms	54
Determining the Type of Operator Interaction for an Alarm	55
Setting the Default Display Mode and Alarm Parameters	56
Entering the Text for an Alarm	57
Embedding a Variable into the Text of an Alarm	57
Configuring the Language Sets for the TD Device (TD 200C, TD 200 only)	59
Notes for Using the Simplified Chinese Character Set	60
Assigning the V Memory Address for the Parameter Block	61
Finishing the Configuration for the TD Device	61
5 Operating Your TD Device	63
Using the TD Device to Access Screens and Alarms	64
Displaying Information on the TD Device	66
Using the TD Device to Edit Variables in the S7-200 CPU	67
Accessing the Menus and Screens	68
Entering and Releasing a Password	70
Entering the Password	70
Releasing the Password	70
Viewing the Screens and the Alarms	71
Displaying the Alarms	72
Clearing an Alarm	75
Editing a Variable that is Embedded in an Alarm or a Screen	75
TD Bit Usage	76

Performing Typical or Routine Operator Tasks	78
Viewing the Status of an S7-200 CPU	78
Setting Time and Date in the S7-200 CPU	80
Changing the Language Set (TD 200C and TD 200 only)	81
Cleaning the Keypad	81
Performing Specialized Operator Tasks (Diagnostic/Setup Menu)	82
Setting up the TD Device	83
Viewing the TD Messages Stored in the S7-200 CPU (TD 200C, TD 200 only)	84
Forcing the Inputs and Outputs in the S7-200 CPU (TD 200C, TD 200 only)	84
Changing the Operating Mode of the S7-200 CPU (TD 200C Only)	85
Copying the User Program to a Memory Cartridge (TD 200C Only)	85
Editing the CPU Memory (TD 200C Only)	86
A Technical Specifications and Reference Information	89
General Technical Specifications	90
Certificates, Directives and Declarations	92
IEC 61131-2	92
Notes on the CE Symbol	92
EMC Directive	92
ATEX Directive (Explosion Protection Guidelines)	92
Declaration of Conformity	92
Observing the Setup Guidelines	92
Approvals for USA, Canada and Australia	93
FM Approval Notes	93
Standard TD Character Set (TD 200C, TD 200 only)	94
ALT Key Combinations for International and Special Characters	95
Bar Graph Character Set (TD 200C, TD 200 only)	96
Arabic Character Set (TD 200C, TD 200 only)	97
Baltic Character Set	98
Simplified Chinese Character Set	99
Notes for Using the Simplified Chinese Character Set	99
Cyrillic Character Set	100
Greek Character Set	101
Hebrew Character Set (TD 200C, TD 200 only)	102
Latin 1 Character Set	103
Latin 2 Character Set	104
Turkish (Latin 5) Character Set	105

B	Connecting Multiple Devices on a Network	107
	Communicating with Multiple CPUs	108
	Determining the Distances, Transmission Rate, and Cable	108
	Using Repeaters on the Network	109
	Selecting the Network Cable	109
	Biasing and Terminating the Network Cable	110
	Building a TD/CPU Cable	110
	Making a Cable That Supplies Power to the TD Device	111
	Making a Cable That Does Not Supply Power to the TD 200 (TD 200C and TD 200 only)	111
	CPU Grounding and Circuit Reference Point Guidelines for Using Isolated Circuits	112
C	Troubleshooting	113

Index

Product Overview

The S7-200 TD devices provide a low-cost human-machine interface (HMI), allowing an operator or user to interact with your application.

The TD devices allow you to configure a set of hierarchical user menus to provide additional structure for the interaction with your application. You can also configure the TD device to display alarms or messages that are enabled by specific bits in the S7-200 CPU.



Tip

The TD devices provide additional functionality, such as the hierarchical user-defined menus. The TD 200C and the TD 200 are fully compatible with projects that were created with earlier versions of the TD 200 (prior to TD 200 V3.0, which supported only the bit-enabled messages from the S7-200 CPU).

You can use the TD 200C or the TD 200 device with an existing TD configuration without having to modify the control program in the S7-200 CPU.

The TD 100C is not compatible with the TD 200 devices.

In This Chapter

Introducing the S7-200 Text Display (TD) Devices	2
Features of the TD Devices	3
International Languages and Characters Support	4
Comparing the TD 100C, the TD 200 and the TD 200C	5
Using the TD Device to Access Screens and Alarms	6
Dividing Information into Screens and Bit-Enabled Alarms	7
Installation and Configuration Tasks	9
Creating a Custom Faceplate for The TD Device	12
Printing the Custom Faceplate for the TD Device	13
Printer Requirements	13
Ordering Additional Faceplate Material	13

Introducing the S7-200 Text Display (TD) Devices

Your S7-200 TD device is a 2- or 4-line text display device that can be connected to the S7-200 CPU. The TD device allows you to view, monitor, and change the process variables pertaining to your application.

The S7-200 product family provides three TD devices:

- TD 100C:** The TD 100C has a 4-line text display with 2 font choices. Your display can have 16 characters per line for a total of 64 characters, or you can use a bold font with 12 characters per line for a total of 48 characters. The faceplate of the TD 100C offers complete flexibility of the keypad layout and faceplate design.

You can create a custom keypad with up to 14 buttons (keys) of variable size, with varying shapes, colors, or fonts that can be layered onto any background image.

- TD 200C:** The TD 200C has a 2-line text display with 20 characters per line for a total of 40 characters. The faceplate of the TD 200C offers complete flexibility of the keypad layout and faceplate design.

You can create a custom keypad with up to 20 buttons (keys) of variable size, with varying shapes, colors, or fonts that can be layered onto any background image.

- TD 200:** The faceplate of the TD 200 provides four keys with predefined, set-bit functions and allows up to eight set-bit functions by using the SHIFT key.

The TD devices receive power from the S7-200 CPU through the TD/CPU cable. The TD 200C and TD 200 devices can also receive power from a separate power supply.

The TD devices contain the following elements:

- Text display area:** The TD 200C and TD 200 has a backlit liquid crystal display (LCD) with a resolution of 33 x 181 pixels. The TD 100C has a liquid crystal display (LCD) with a resolution of 132 x 65 pixels.
- Communication port:** 9-pin D-connector
- Power connector:** The TD 200C and TD 200 have a connector for using an optional external power supply (power for the TD device is typically supplied by the S7-200 CPU through the TD/CPU cable). The TD 100C does not have the option of using an external power supply.

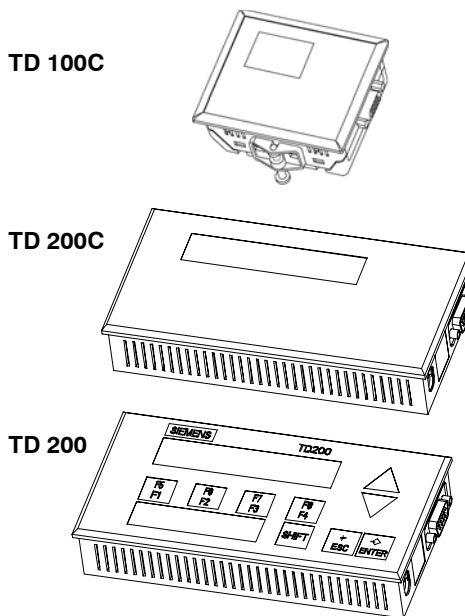

Figure 1-1 Text Display (TD) Devices

STEP 7-Micro/WIN provides tools to help you configure the TD devices. Using the following tools, you can easily program your S7-200 to display text messages and other data:

- Text Display wizard helps you configure messages for the TD devices.
- Keypad Designer helps you to configure the custom keypad for the TD 100C and the TD 200C. The Keypad Designer includes samples and templates in the following directories:
 - Sample bitmaps for buttons and backgrounds:
C:/Program Files/Siemens/TD Keypad Designer/Images
 - Sample projects:
C:/Program Files/Siemens/TD Keypad Designer/Samples
 - Sample template (for printing multiple copies of the faceplate):
C:/Program Files/Siemens/TD Keypad Designer/Templates

Each TD device functions as a network master when it is connected over a network that contains one or more S7-200 CPUs. The TD device is also designed to operate with other masters in a network. Multiple TD devices can be used with one or more S7-200 CPUs connected to the same network. More than one TD device can connect to the same S7-200 CPU.

Features of the TD Devices

You can use your TD device to perform the following tasks:

- Viewing a hierarchy of user menus and screens that allow an operator to interact with the application or process
You create these user menus and screens with the Text Display wizard of STEP 7-Micro/WIN
- Displaying alarms (bit-enabled messages) that are generated by the S7-200 CPU
You define these alarms with the Text Display wizard of STEP 7-Micro/WIN
- Modifying designated program variables
The TD device allows you to define a variable as either a text string or a numeric string:
 - Text string: All characters in a variable are editable
 - Numeric string: Only the numeric characters are editable (the cursor skips over all non-numeric characters)
 The TD device allows you to define a variable as a word, double word, or real
- Forcing or unforcing I/O points: You can force individual I/O points in the S7-200 CPU to be on or off (TD 200C and TD 200 only)
- Setting the time and date (if the S7-200 CPU supports a real-time clock)
- Viewing the CPU status (including version information)

The TD 200C provides additional functionality for interacting with the S7-200 CPU:

- You can change the operating mode (RUN or STOP) of the S7-200 CPU
- You can load the user program in the S7-200 CPU to a memory cartridge
- You can access and edit the data stored in the memory of the S7-200 CPU

International Languages and Characters Support

The TD 200C and TD 200 devices provide a default TD character set which supports bar graph characters. The TD 100C, TD 200C and TD 200 devices support the following Windows character sets for displaying messages:

- Arabic (TD 200C and TD 200 only)
- Baltic
- Chinese (Simplified Chinese)¹
- Cyrillic
- Greek
- Hebrew (TD 200C and TD 200 only)
- Latin 1 (with Boldface)
- Latin 2 (with Boldface)
- Turkish (Latin 5)

The TD devices provide system menus and prompts in six languages: English, German, French, Spanish, Italian, and Simplified Chinese.

In the TD 100C, all fonts except Simplified Chinese are available in two sizes: 12 and 16 characters per row. All the 12 character fonts are bold.

Table 1-1 Fonts Supported by the TD Devices

TD 100C	TD 200	TD 200C
Latin 1	Latin 1	Latin 1
-	Latin 1 Bold	Latin 1 Bold
Latin 2	Latin 2	Latin 2
-	Latin 2 Bold	Latin 2
Cyrillic	Cyrillic	Cyrillic
Greek	Greek	Greek
Turkish	Turkish	Turkish
Baltic Rim	Baltic Rim	Baltic Rim
-	Arabic	Arabic
-	Hebrew	Hebrew
-	Original TD 200	Original TD 200
-	Bar Graph	Bar Graph
Simplified Chinese ¹	Simplified Chinese	Simplified Chinese

¹ The TD 100C includes approximately 1900 out of the possible 6763 Chinese characters.

Comparing the TD 100C, the TD 200 and the TD 200C

Table 1-2 Comparing the features of the TD Devices

Feature	TD 100C V 1.0	TD 200 V3.0	TD 200C
Text display area	4 lines, up to 64 characters (up to 16 characters per line)	2 lines, up to 40 characters (up to 20 characters per line)	2 lines, up to 40 characters (up to 20 characters per line)
Keypad options	User-designed custom keypad Standard keypad	Standard keypad	User-designed custom keypad Standard keypad
Configurable buttons	Custom keypad: Up to 14 (user-configurable) Standard keypad: 2	Standard keypad: 4 (up to 8 when using SHIFT)	Custom keypad: Up to 20 (user-configurable) Standard keypad: 4 (up to 8 when using SHIFT)
System buttons (pre-configured)	ENTER, ESC (Escape), UP, DOWN, LEFT and RIGHT arrows, F1, F2	ENTER, ESC (Escape), SHIFT, UP and DOWN arrows	Configurable ENTER, ESC (Escape), SHIFT, UP, DOWN, LEFT, and RIGHT arrows
User-defined menus and user screens	Maximum of 32 screens Up to 4 user menus, with up to 8 screens per user menu	Maximum of 64 screens Up to 8 user menus, with up to 8 screens per user menu	Maximum of 64 screens Up to 8 user menus, with up to 8 screens per user menu
Alarms (from the S7-200 CPU)	Up to 40 alarm messages	Up to 80 alarm messages	Up to 80 alarm messages
Alarm indicator (icon)	Yes	Yes	Yes
Variables embedded in an alarm or screen	1 per line (1 for one-line alarms, 2 for two-line alarms, 4 for a screen)	Up to 6 variables per alarm or screen	Up to 6 variables per alarm or screen
Icons (graphics) embedded in a message	No	No	Yes
System menu options	Release the password Set the time and date CPU status Clean keypad	Force I/O Release the password Set the time and date CPU status Switch languages (if configured) Clean keypad	Force I/O Release the password Set the time and date CPU status Switch languages (if configured) Change the CPU operating mode Clean keypad Edit the CPU memory Program a memory cartridge
Password protection	Yes	Yes	Yes
Multiple language sets	No	Yes	Yes
Character sets supported (for displaying different languages)	7 character sets: Latin 1, Latin 2, Chinese (Simplified), Cyrillic, Baltic, Greek, Turkish	10 character sets: Latin 1/Bold, Latin 2/Bold, Chinese (Simplified), Cyrillic, Arabic, Baltic, Greek, Hebrew, Turkish, and Standard TD (includes Bar Graph)	10 character sets: Latin 1/Bold, Latin 2/Bold, Chinese (Simplified), Cyrillic, Arabic, Baltic, Greek, Hebrew, Turkish, and Standard TD (includes Bar Graph)
Languages for system menus and error messages	6 languages: English, French, German, Italian, Spanish, and Chinese	6 languages: English, French, German, Italian, Spanish, and Chinese	6 languages: English, French, German, Italian, Spanish, and Chinese
Feedback (when pressing a button)	Visual indicator in the text display area	Tactile dome over the buttons on the keypad and visual indicator	Visual indicator in the text display area

Using the TD Device to Access Screens and Alarms

When you configure the TD device with the Text Display wizard of STEP 7-Micro/WIN, you create the screens and alarms for the TD device. You use the buttons on the keypad of the TD device to navigate through the screens and menus. The TD 200 device uses the standard TD keypad. The standard faceplates for the TD devices are shown in Figure 1-2.

The TD 100C and the TD 200C allow you to create your own custom-designed buttons with specialized functions.

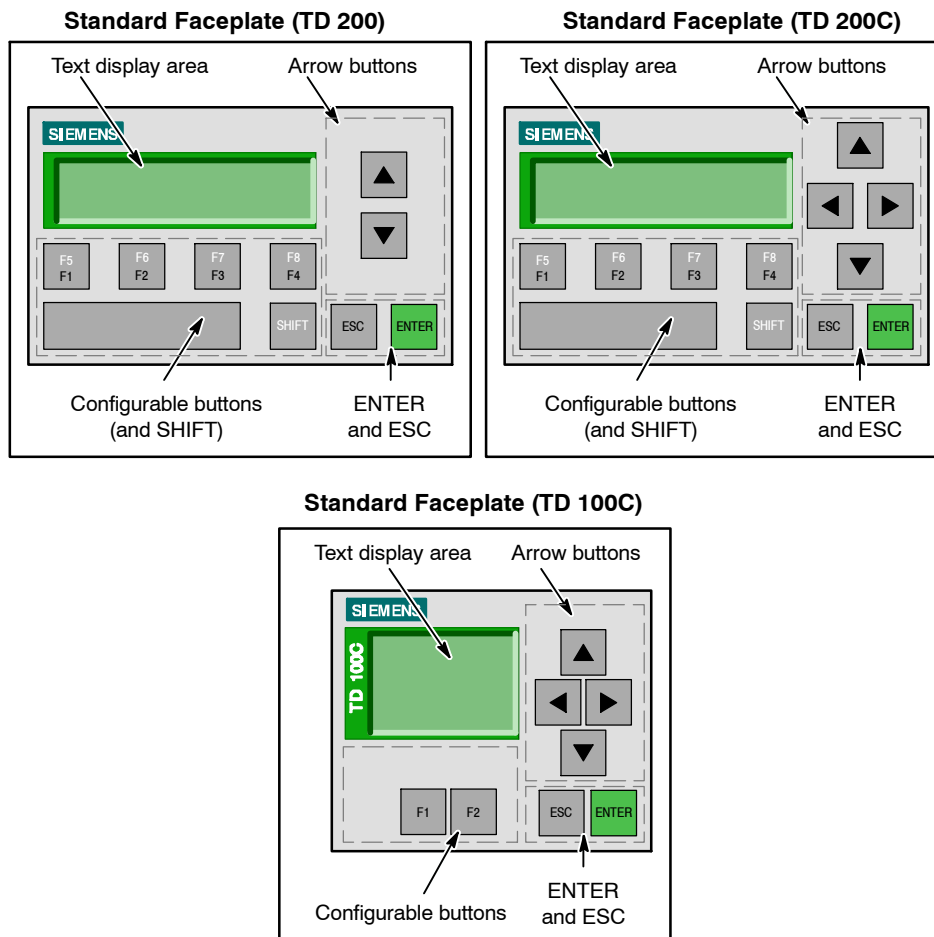

Figure 1-2 Standard Keypad Configuration for the TD Devices

Dividing Information into Screens and Bit-Enabled Alarms

As shown in Figure 1-3, you can configure the TD device to display screens (which are initiated by operator action) and bit-enabled alarms (which are initiated by the S7-200 CPU).

- ❑ **Screens:** You can create screens that allow the operator (using the TD device) to initiate the interaction with the S7-200 CPU. With the TD device, you can configure a user menu (up to 8 entries or groups for the TD 200C and TD 200, and up to 4 entries or groups for the TD 100C) that provides a hierarchy for the screens. You can create up to 8 screens for each menu item or group.
- ❑ **Alarms:** You can create alarm messages that allow the user program in the S7-200 CPU to initiate interaction with the operator by displaying a message on the TD device.

During the configuration of the TD device, you also designate which type of message (screens or alarms) will be the default display mode for the TD device. After power-up, the TD device goes to the default display mode. Also, the TD device returns to the default display mode after a period of inactivity (if no buttons have been pressed for one minute).

Storing the Screens and Alarms in the Parameter Block

The S7-200 CPU stores the ASCII text, embedded variables, and format information for the alarms and screens in a parameter block located in V memory. You use the Text Display wizard to configure the starting address for the parameter block in V memory, and the Text Display wizard allocates the memory required to store the information for the TD device.

If you configure more than one parameter block for the S7-200 CPU (with each parameter block having a different range of addresses in V memory), you can connect several TD devices to that one S7-200 CPU. You configure the V memory address for the specific parameter block for each of the TD devices. The Diagnostic Menu of the TD device provides a TD Setup command for specifying the starting address of the parameter block.

**Tip**

The parameter block for the TD 100C is not compatible with the parameter blocks for the TD 200C or the TD 200.

Displaying the Screens and Alarms on the TD Device

When the operator uses the buttons on the TD device to select a screen, the TD device reads the screen information from the parameter block (stored in V memory of the S7-200 CPU) and displays the appropriate screen.

When you configure an alarm, you also configure an alarm bit for enabling a specific alarm. The logic of your user program sets this alarm bit to display the alarm on the TD device. When you create the text for the alarm, you also designate the alarm bit. If you configured an alarm to require acknowledgement by an operator, that alarm also has an acknowledge bit. The TD device continuously polls the alarm bits to determine which alarms have been enabled.

To display an alarm on the TD device, your user program in the S7-200 CPU must first set the alarm bit for the specific alarm. When your user program sets one of the alarm bits, the TD device then reads the alarm bits in the parameter block in the S7-200 CPU and displays the corresponding alarm message.

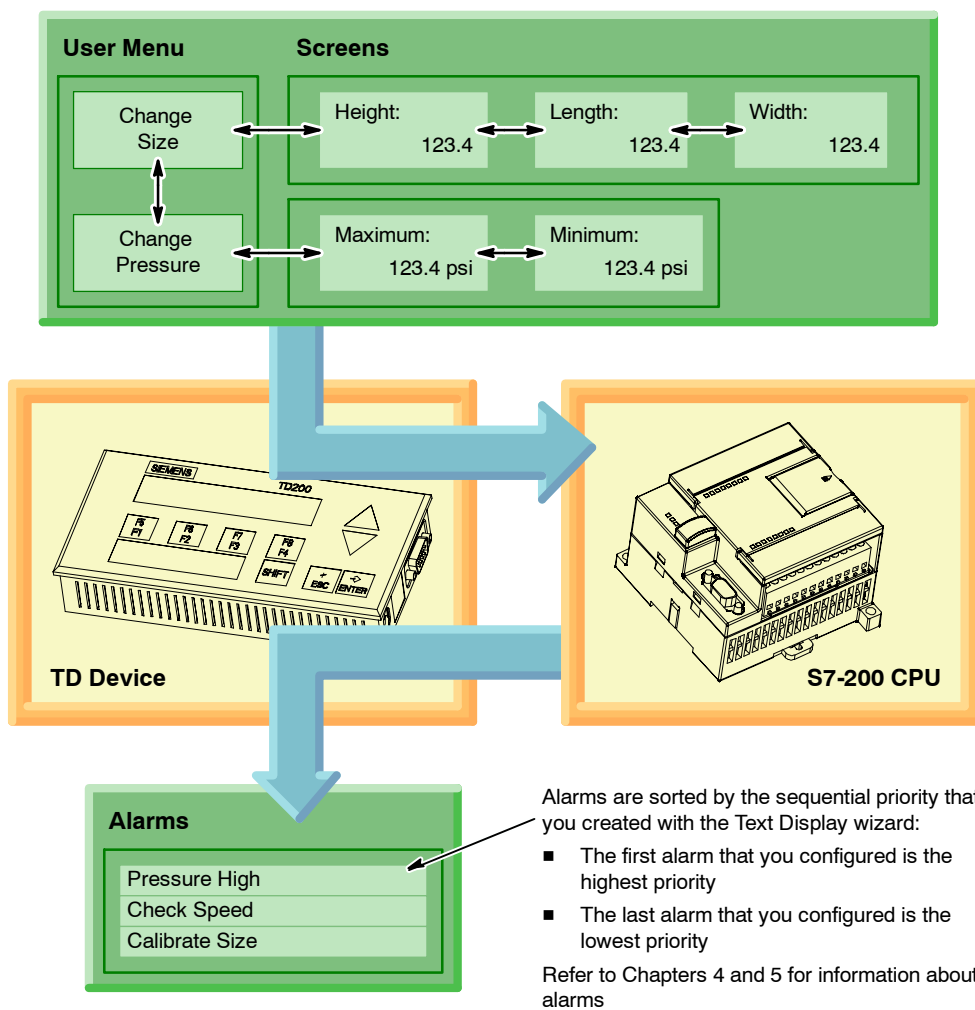

Figure 1-3 Screens and Alarms

Installation and Configuration Tasks

As shown in Figure 1-4, you use the Text Display wizard of STEP 7-Micro/WIN to configure the TD device. You can create a custom faceplate for the TD 100C and TD 200C. The Keypad Designer creates a keypad configuration file for the Text Display wizard.

Figure 1-5 and Figure 1-6 provide an overview of the tasks for installing the TD device. Refer to Chapter 2.

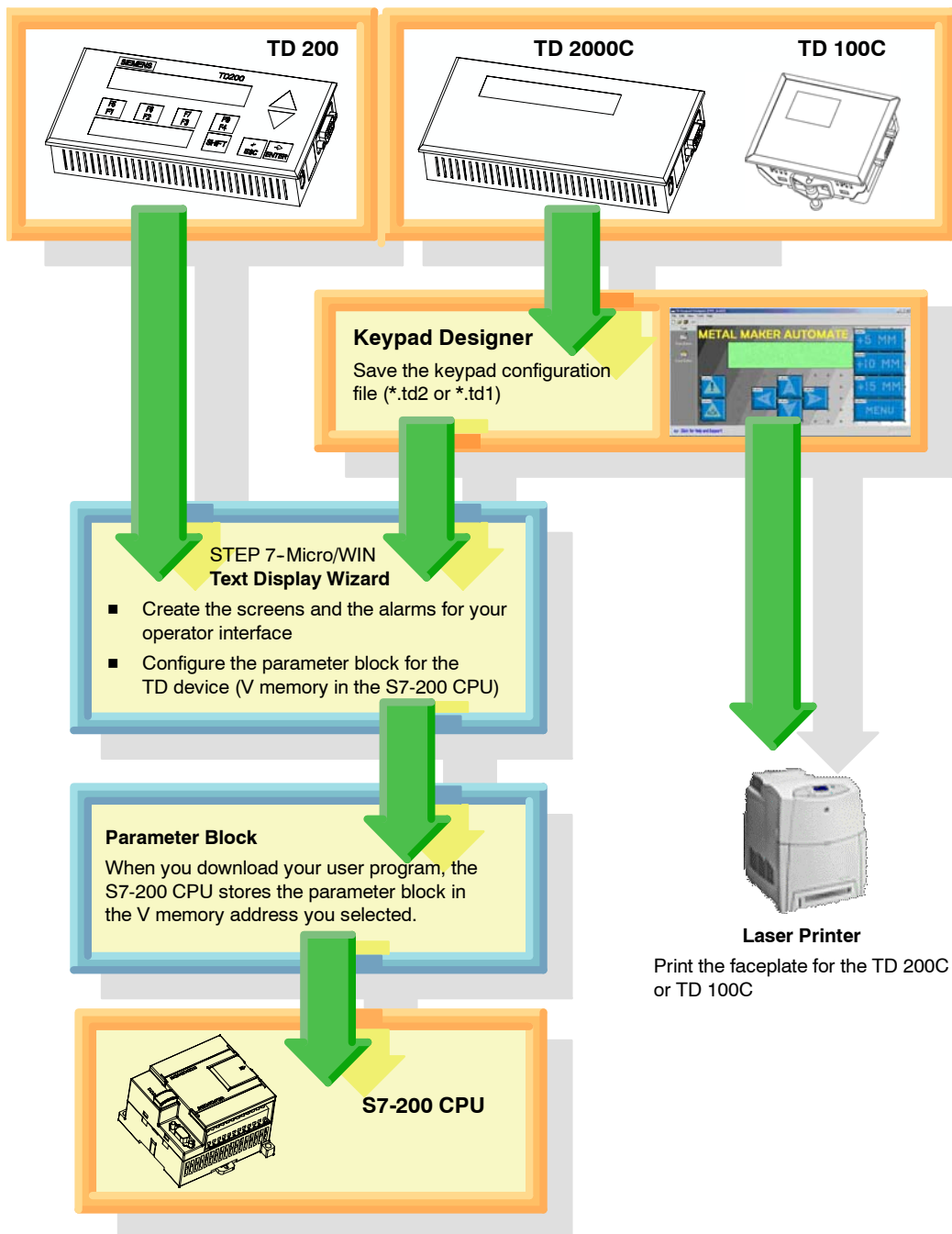
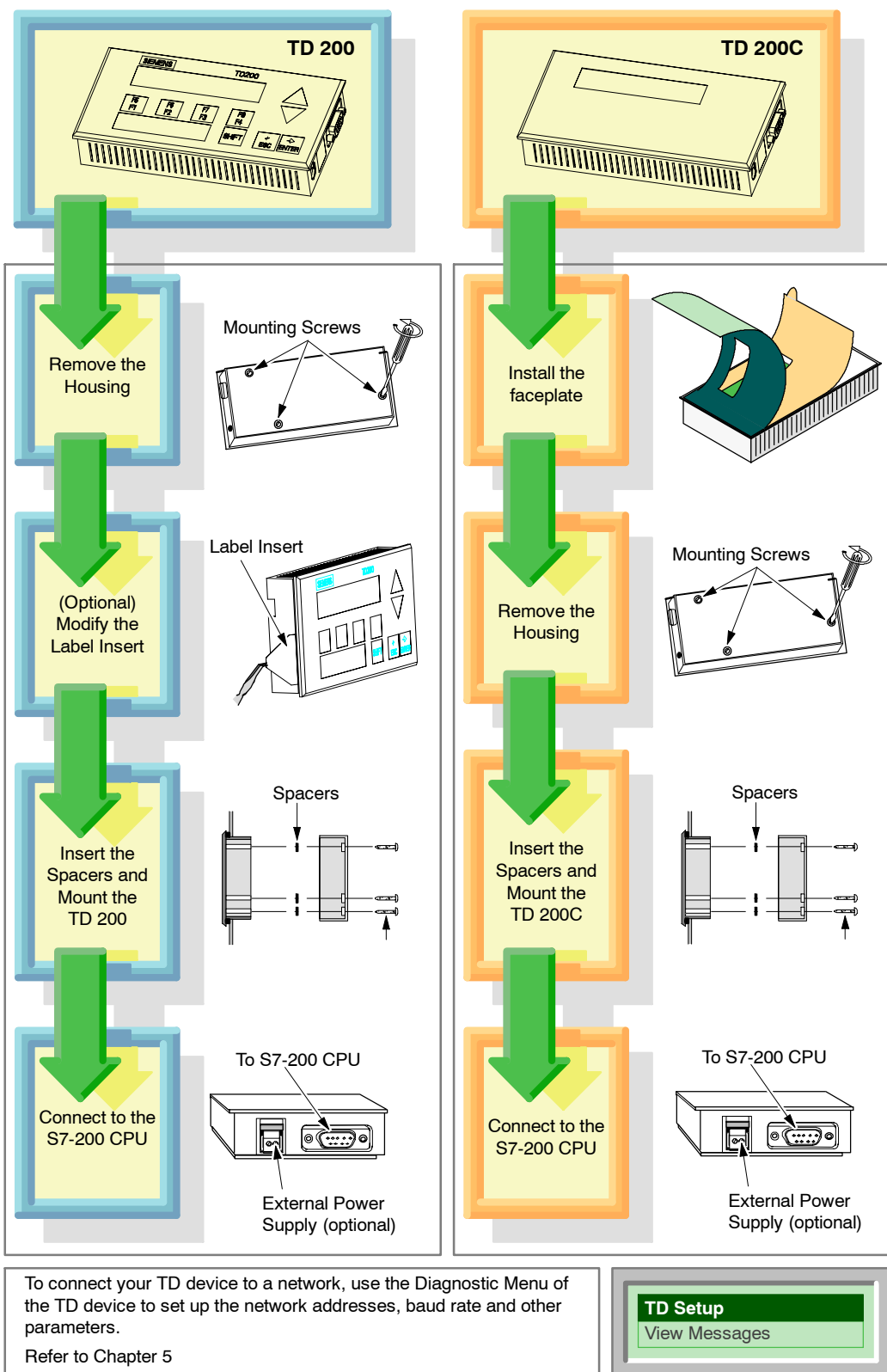
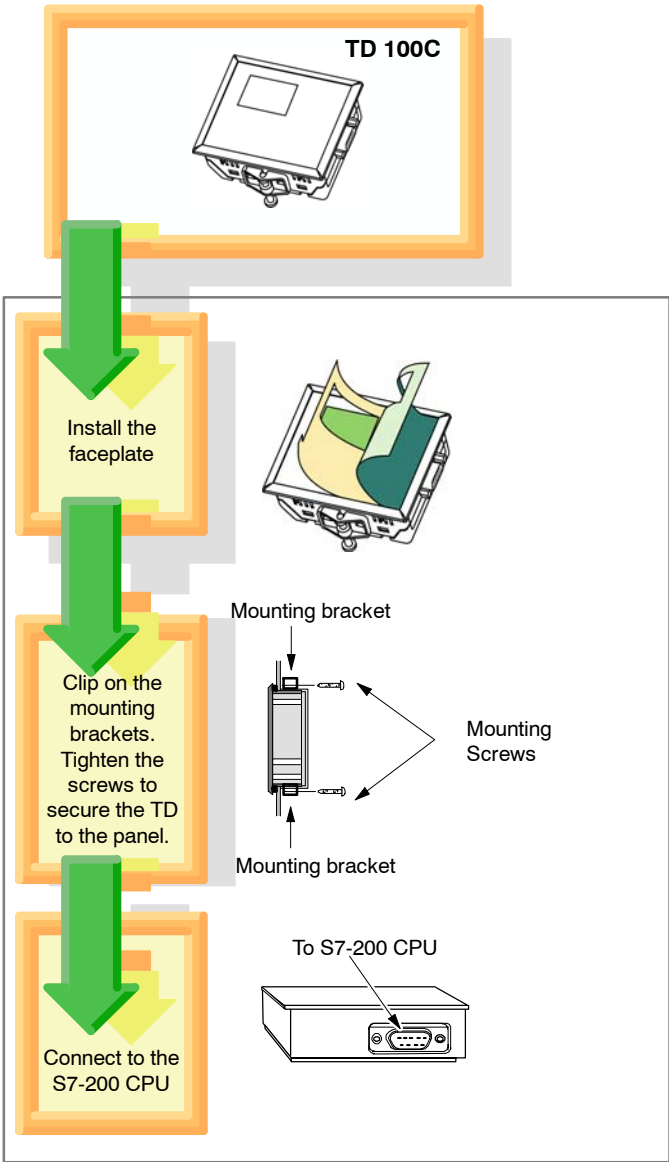

Figure 1-4 Configuration Tasks for the TD Devices



To connect your TD device to a network, use the Diagnostic Menu of the TD device to set up the network addresses, baud rate and other parameters.
Refer to Chapter 5

Figure 1-5 Installing Your TD Device



To connect your TD 100C device to a network, use the TD Setup Menu of the TD 100C device to set up the network addresses, baud rate and other parameters. Refer to Chapter 5



Figure 1-6 Installing Your TD 100C Device

Creating a Custom Faceplate for The TD Device

With the TD 100C and the TD 200C, you can design a custom faceplate that incorporates buttons (keys) of varying size, with varying shapes, colors, or fonts that can be layered onto any background image. You use the Keypad Designer to create the custom-designed layout for the keypad.

As shown in Figure 1-7, you use several applications to create a custom faceplate:

- Keypad Designer: Creates the layout and the configuration for the keypad
- Third-party graphics application: Designs the graphical appearance of the faceplate
- STEP 7-Micro/WIN (Text Display wizard): Configures the parameter block for the TD 100C and the TD 200C
- Word-processing application (optional): Prints multiple copies of the faceplate

Siemens provides document files (in 6 languages) for Microsoft Word that help you to align the panel images for the perforations on the A4 blank faceplate material. To open these documents, browse to the Templates subdirectory under the Keypad Designer application (C:/Program Files/Siemens/TD Keypad Designer/Templates) and select the template for your TD device and language.

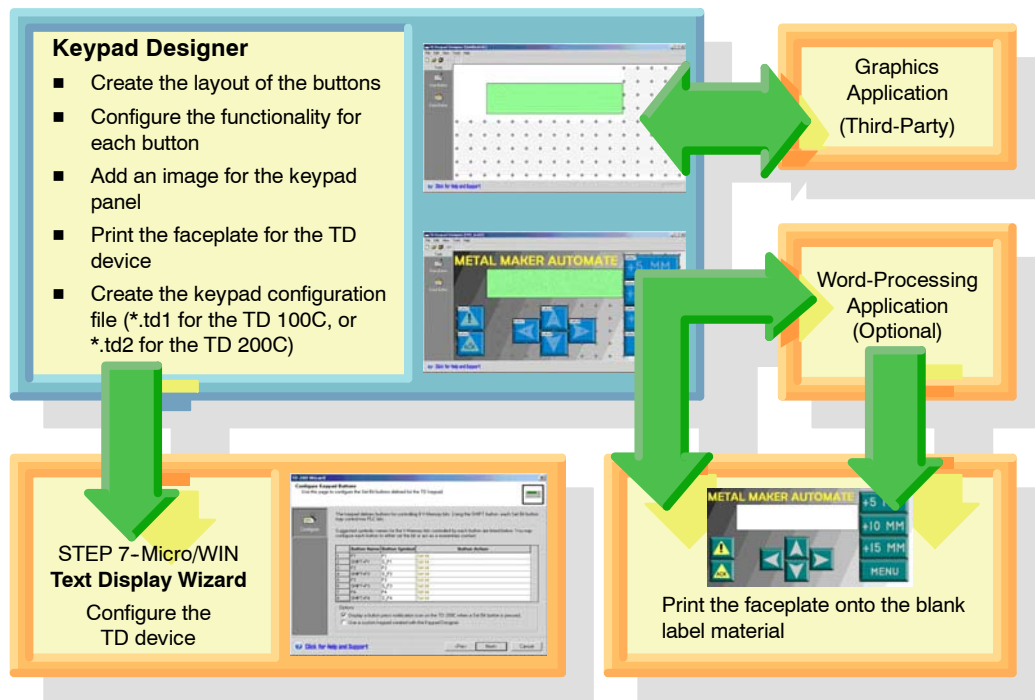

Figure 1-7 Using the Keypad Designer and Other Applications to Create a Custom Faceplate

Printing the Custom Faceplate for the TD Device

The TD 100C and the TD 200C ship with one blank faceplate (envelope-size) for printing the faceplate. The faceplate is constructed from durable, polyester material which has been designed especially for use on HMI faceplates.

- You can print a single faceplate directly from the Keypad Designer on the envelope-sized blank faceplate.
- To print multiple faceplates, you can use the Microsoft Word template (provided in the Templates subdirectory) that ensures your faceplate design is properly sized. You can print multiple faceplates onto the perforated A4-size blank faceplate sheets.

Refer to Chapter 3 for specific information about printing the custom faceplate for the TD 100C or the TD 200C.



Tip

The faceplate material is specially treated on one side to accommodate printing with a laser printer. The treated surface is up (or toward you) when you are holding the material with the cut corner in the top right of the sheet.

Ensure that the material is correctly inserted into the laser printer so that the faceplate prints the reversed image onto the treated surface of the material. You must print a reversed-image version of the faceplate onto the faceplate material.

Before printing your custom faceplate onto the blank faceplate sheet, first test your design by printing the faceplate onto regular paper. You can then temporarily use the paper faceplate to test the functionality of the design with your TD 100C or TD 200C.

Printer Requirements

To print your custom-designed image onto the blank faceplate material, you must use a laser printer that supports the following features:

- Paper size: The laser printer must be able to print on both the A4 (210 mm X 297 mm) and envelope formats.
- Color: The laser printer must support color printing.
- Transparencies: The laser printer must support the printing of transparencies (or other non-paper stock).

Ordering Additional Faceplate Material

You can order additional blank faceplates for your TD device in perforated A4-size sheets (10 sheets/package). The faceplate material is especially designed for printing on a laser printer. The blank faceplate sheets also allow you to utilize the services of professional printing vendors that specialize in laser printing in order to create large quantities of high-quality faceplates.

Contact your local Siemens representative or distributor to purchase additional quantities of the faceplate material. The order numbers are shown below:

- For the TD 200C, the order number for additional blank faceplates is 6ES7 272-1AF00-7AA0
- For the TD 100C, the order number for additional blank faceplates is 6ES7 272-1BF00-7AA0

2

Installing Your TD Device

You can install your TD device for easy access, whether on a panel or on a door of an enclosure.

Installed properly, the TD device meets the following standards for protection:

- IP 65 (mounted on front of the panel)
- IP 20 (mounted on casing)
- UL 50 Type 4X

Refer to Appendix A for technical specification and for information about agency approvals and other certifications.



Tip

You can use the TD 200, version 3.0 and the TD 200C, version 1.0 with an existing TD 200 configuration without having to modify the control program in the S7-200 CPU. The TD 100C is not compatible with the TD 200 devices.

In This Chapter

Components Shipped with the TD Devices	16
Mounting the TD 200C and TD 200 in a Panel or on a Surface	17
Preparing the Mounting Surface for a TD 200C or TD 200	17
Preparing the TD 200C and TD 200 for Mounting	17
Positioning the Spacers for the TD 200C and TD 200	17
Mounting the TD 200C and TD 200	18
Mounting the TD 100C in a Panel or on a Surface	18
Preparing the Mounting Surface for a TD 100C	18
Mounting the TD 100C	18
Customizing the Labels for the Keys of the TD 200	19
Modifying the Label Insert of the TD 200	19
Creating a Custom Label Insert for the TD 200	19
Installing a Faceplate for the TD 100C and the TD 200C	20
Connecting the TD/CPU Cable	21
Supplying Power for the TD Device	22
Establishing a Connection for Your TD Device	23
TD 100C and TD 200C	23

Components Shipped with the TD Devices

The TD devices ship with the following components:

- Gasket: Protective cushion with gasket for installing the TD device in inclement environments
- TD/CPU cable: 9-pin, straight-through cable that provides both communication and power to the TD device.

If the TD 100C is purchased outside North America, the cable must be ordered separately. The TD 100C, if purchased in North America includes the TD/CPU cable. The order number for the TD/CPU cable is 6ES7-901-3EB10-0XA0.

- Spacers: Self-adhesive spacers for mounting the TD device in a panel (TD 200C and TD 200 only)
- Mounting brackets: Brackets for mounting the TD device in a panel (TD 100C only)

The TD 200 ships with a pull-out user label that allows you to label the function keys for your application.

The TD 100C and the TD 200C ship with a blank faceplate that you can customize and a pre-printed faceplate for the standard TD keypad. The faceplate is constructed from durable, polyester material which has been designed specifically for use for HMI faceplates.



Tip

To print your custom-designed image onto the blank faceplate material, you must use a laser printer that supports the printing of transparencies on both A4 and envelope formats and also supports color printing.

General TD Installation Information



Tip

To ensure compliance with IP 65 or UL 50 Type 4X:

- The minimum panel thickness must be at least 1.5 mm.
- For the TD 200C and TD 200, the mounting screws must be tightened to a torque of 0.7 N-m.
- For the TD 100C, the mounting screws must be tightened to a torque of 0.2 Nm (about 0.5 mm the height of the seal).
- The gasket must be replaced whenever the TD device is removed and reinstalled.

To procure new gaskets, contact your Siemens distributor or sales representative.

This equipment is suitable for use in Class I, Division 2, Groups A, B, C, D; Class I, Zone 2, Group IIC; or non-hazardous locations.



Warning

WARNING - EXPLOSION HAZARD!

DO NOT DISCONNECT WHILE CIRCUIT IS LIVE UNLESS LOCATION IS KNOWN TO BE NON-HAZARDOUS



Warning

WARNING - EXPLOSION HAZARD!

Substitution of components may impair suitability for Class I, Division 2 or Zone 2.

Mounting the TD 200C and TD 200 in a Panel or on a Surface



Tip

If you are using a customized label insert for your TD 200 device, you must first install the new label insert before you mount the TD device.

Preparing the Mounting Surface for a TD 200C or TD 200

To prepare the surface where the TD 200C or TD 200 is to be mounted or installed:

- Cut a 138 mm x 68 mm hole in the mounting surface (DIN 43700). See Figure 2-1.
- Refer to Table A-1 for the outside dimensions of the TD 200C or TD 200 device.

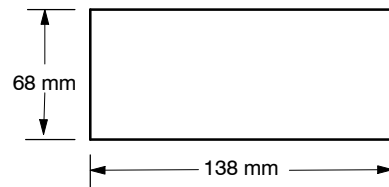

Figure 2-1 Dimensions for Cutting a Hole in the Mounting Surface of the TD 200C and TD 200

Preparing the TD 200C and TD 200 for Mounting

Refer to Figure 2-2 and use the following procedure to separate the front cover from the housing of the TD 200C and TD 200 :

1. Use a flat-head screwdriver or a T8 Torx screwdriver to remove the three screws from the rear of the TD device.
2. Remove the front cover of the TD device from the housing.

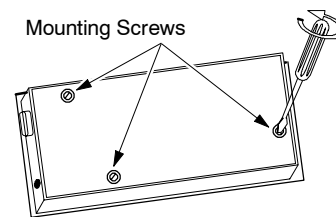

Figure 2-2 Removing the Mounting Screws of the TD 200C and TD 200

Positioning the Spacers for the TD 200C and TD 200

The self-adhesive spacers (included with the TD 200C and TD 200) maintain the pressure on the TD device circuit board when the TD device is assembled. The number of spacers required is dependant upon the thickness of the mounting surface.

Refer to Figure 2-3 and use the following procedure to position the spacers:

1. Determine the number of spacers required, based on the thickness of the panel:
 - For up to 1.5 mm, use one spacer.
 - For 1.5 mm to 4.0 mm, use two spacers.
2. Place the spacers over the screw holes on the inside of the backplate.

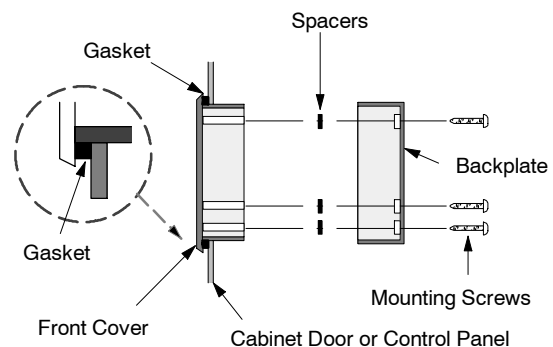

Figure 2-3 Positioning Spacers on the TD 200C and TD 200

Mounting the TD 200C and TD 200

Refer to Figure 2-3 and use the following procedure to complete the mounting of your TD 200C and TD 200:

1. Remove the gasket from the protective cushion.
2. Place the supplied gasket on the frontplate of the TD device.
3. Install the spacers (if required).
4. Fit the frontplate into the cutout you made in the mounting surface.
5. Secure the backplate onto the frontplate of the TD device using the screws you removed from the backplate. Carefully tighten the screws until snug.

Mounting the TD 100C in a Panel or on a Surface

Preparing the Mounting Surface for a TD 100C

To prepare the surface where the TD 100C is to be mounted or installed:

- Cut a 69 mm x 82 mm hole in the mounting surface (DIN 43700). See Figure 2-4.
- Refer to Table A-1 for the outside dimensions of the TD 100C device.

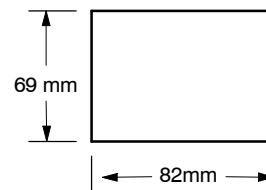

Figure 2-4 Dimensions for Cutting a Hole in the Mounting Surface of the TD 100C

Mounting the TD 100C

Refer to Figure 2-5 and use the following procedure to complete the mounting of your TD 100

1. Remove the gasket from the protective cushion.
2. Place the supplied gasket on the frontplate of the TD device.
3. Fit the TD 100C into the cutout you made in the mounting surface.
4. Attach the special mounting brackets (included) to the TD 100C.
5. Tighten the mounting screws on the mounting brackets to secure the TD 100C to the panel.

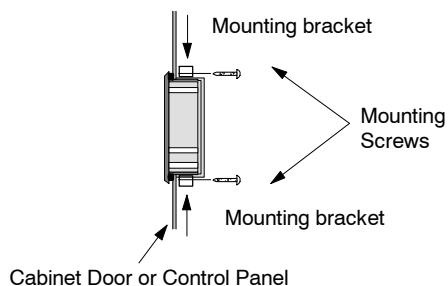

Figure 2-5 Mounting the TD 100C

Customizing the Labels for the Keys of the TD 200

The TD 200 allows you to define the functions for four of the nine keys (or buttons) on the standard faceplate. You can remove the label insert of the TD 200 and designate the functions assigned to those user-defined keys. You can also replace the standard TD 200 insert with your own custom insert for the user-defined keys.

You must remove (at least partially) the TD housing in order to access the label insert from underneath the front cover of the TD device.

Modifying the Label Insert of the TD 200

1. Remove the three screws on the back of the TD device and remove the front cover from the housing.
2. Remove the label insert by pulling the label insert tab out of the label slot with a pair of pointed tweezers.
3. Turn the label insert over and create your own label design. (The reverse side of the label insert is blank.)
4. Insert the label by placing the corner of the label into the label slot.
5. Reinstall the front cover into the back housing.
6. Replace and tighten the three screws on the back of the TD device to ensure that the cover and housing are secure.

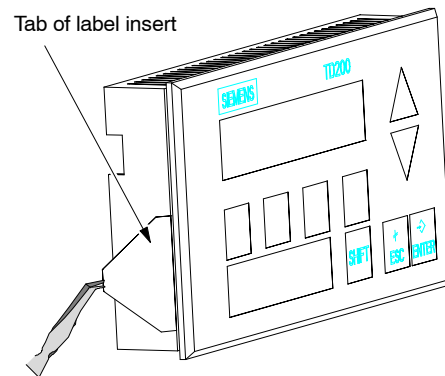

Use tweezers to grasp the tab of the label insert

Figure 2-6 Removing the Label Insert

Creating a Custom Label Insert for the TD 200

Figure 2-7 provides the dimensions for creating your own custom label insert. These dimensions are valid for TD 200, hardware revision 3 and later.

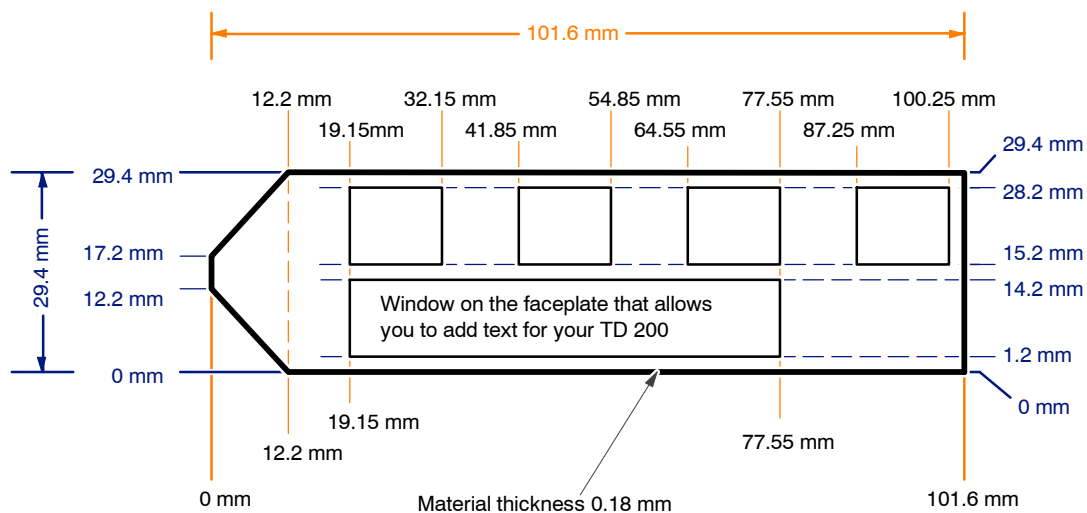

Figure 2-7 Dimensions for a Custom Label Insert

Installing a Faceplate for the TD 100C and the TD 200C

The TD 100C and TD 200C ship with a blank faceplate (envelope size) for creating a custom-designed faceplate.

These TD devices do not ship with the faceplate attached. The front of the TD is an adhesive surface (shipped with a protective paper) that allows you to attach your custom faceplate.

Refer to Chapter 3 for information about designing and printing a custom faceplate.

The upper diagram of Figure 2-8 shows the dimensions for the faceplate of the TD devices. Blank faceplate material is available in two sizes:

- Envelope size for printing a single faceplate
- A4 size (210 mm x 297 mm) for printing multiple copies of the faceplate

You must cut the faceplate from the envelope-sized material, but the A4 material is perforated to allow you to remove the faceplates without cutting.

Use the following procedure to install your custom faceplate on the TD device. The example shown here is for the TD 200C. Installing a faceplate on a TD 100C is similar; the differences are noted below.

1. Remove the blue protective film covering the display window of the TD device and the back of the preprinted (standard) faceplate.
2. As shown in Figure 2-8, remove the strip of protective paper on the left side of the TD 200C to expose a strip of the adhesive. For the TD 100C, this strip is on the right side of the device.
3. Carefully align your custom faceplate on the entire TD 200C, and then seal the faceplate to the exposed adhesive by pressing down on the left side of the faceplate. For the TD 100C, press down on the right side of the faceplate.
4. Carefully lift back the unadhered faceplate and remove the rest of the protective paper from the TD device.
5. Carefully position the faceplate onto the TD device. Firmly press the faceplate onto the adhesive as shown in Figure 2-8, taking care to remove any air bubbles that may have been trapped underneath.

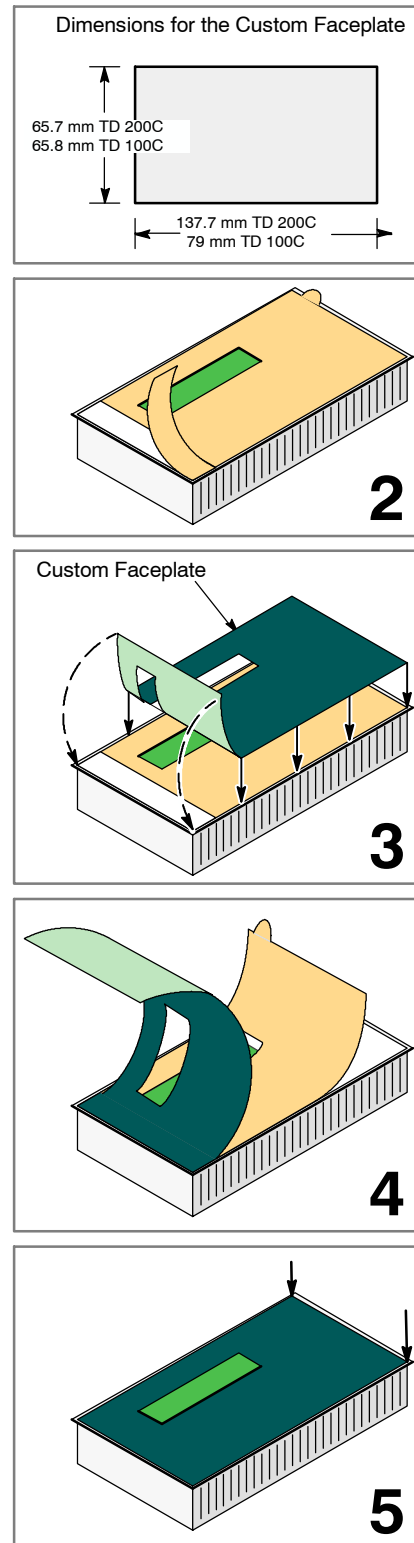

Figure 2-8 Installing a Custom Faceplate on a TD Device

The standard TD faceplates are shown in Figure 1-2. The TD 200C comes configured as a standard TD 200 (with LEFT and RIGHT arrows). The TD 100C comes configured with six standard keys (UP, DOWN, LEFT and RIGHT arrows, ESC, and ENTER).

After creating and installing the custom faceplate on your TD device you must also download the TD configuration that you created with both the Keypad Designer and the Text Display wizard.

- Chapter 3 describes the Keypad Designer
- Chapter 4 describes the Text Display wizard

Connecting the TD/CPU Cable

Caution

Operating the TD device with an ungrounded voltage source can damage the TD device.

The TD device may only be connected to grounded voltage sources. Non-grounded operation can cause the TD device to become damaged.

Always ensure that the voltage source for the TD device is properly grounded.

The TD devices can use the TD/CPU cable for communicating with the S7-200 CPU.

- You can connect the TD device directly to the S7-200 CPU, creating a one-to-one network configuration. In this configuration, one TD device connects to one S7-200 CPU through the TD/CPU cable.
- You can connect multiple TD devices to multiple S7-200 CPUs over a network. The TD device defaults to address 1 and attempts to communicate to a CPU at address 2.

For more information about connecting to multiple CPUs, see Appendix B. For information about changing the default addresses in the TD device, see Chapter 5.

If you require a longer cable (>2.5 m) to connect the TD device to the S7-200 CPU, use PROFIBUS components for the network connection. Refer to the SINEC IK10 Catalog.

Supplying Power for the TD Device

The S7-200 CPU uses the TD/CPU cable to provide power to the TD device. Use this type of power supply when the distance between the TD device and the S7-200 CPU is less than 2.5 m (the length of the TD/CPU cable). The TD 200C and the TD 200 have the option of using an external power supply.



Tip

The TD 100C device must use the TD/CPU cable to provide power from the S7-200 CPU to the TD device. The TD 100C does not have the option of using an external power supply.



Tip

If the distance between the TD 200C or TD 200 and the S7-200 CPU is greater than 2.5 m, use an external 24 VDC power supply.

If you require a longer cable (greater than 2.5 m) to connect the TD device to the S7-200 CPU, use PROFIBUS components for the network connection. Refer to the SINEC IK10 Catalog.

Refer to Appendix B for information about using the TD device on a network.

As shown in Figure 2-9, the TD device provides up to two options for providing power:

- The TD/CPU cable allows the S7-200 CPU to provide power to the TD device over the communications port. This is the only option available for the TD 100C.

For information about the TD/CPU cable and the communications port, refer to Appendix B.

- You can connect the TD 200C or the TD 200 to an external power supply.

The TD 200C or TD 200 requires 120 mA at 24 VDC to operate. An optional power connector is provided with the TD 200C and the TD 200.

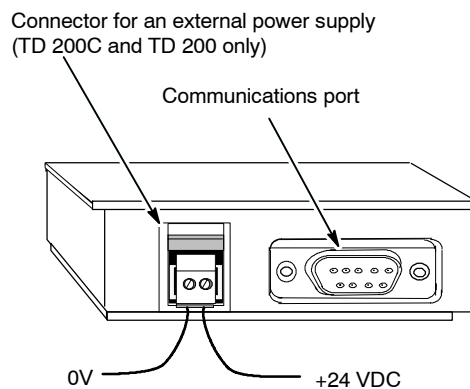

Figure 2-9 Connecting Power to the TD Device

Establishing a Connection for Your TD Device

As described in Chapter 4, you use the Text Display wizard of STEP 7-Micro/WIN to configure the screens, alarms, languages, and custom keypad layout for the TD 100C and the TD 200C. The S7-200 CPU stores this information in a parameter block (V memory).

The TD devices ship with a default configuration and are set to communicate at a rate of 9600 baud. The TD devices must communicate with the S7-200 CPU to be able to read the parameter block.

You must configure your TD device to communicate at the same baud rate as your S7-200 CPU.

TD 100C and TD 200C

Until the TD 100C or TD 200C successfully connects to the S7-200 CPU and reads the parameter block, the TD device remains configured for the standard TD keypad shown in Figure 2-10.

To change the baud rate of your TD device, you use the ESC and ENTER buttons to navigate to the Diagnostic/TD Setup Menu and change the TD Setup parameters. (See Chapter 5.) Because the TD 100C and TD 200C ship with no faceplate attached, it may be difficult to consistently press ESC or ENTER.

The TD 100C and TD 200C ship with a faceplate for the standard TD keypad. In addition, the Keypad Designer provides a sample faceplate for the standard TD keypad in the following directory:

```
C:/Program Files/Siemens/
TD Keypad Designer/Templates
```

For temporary use, you can print this faceplate onto paper and lay the paper on top of the TD device (without removing the covering from the adhesive).

Refer to Chapter 3 for information about opening the Keypad Designer and printing a faceplate.

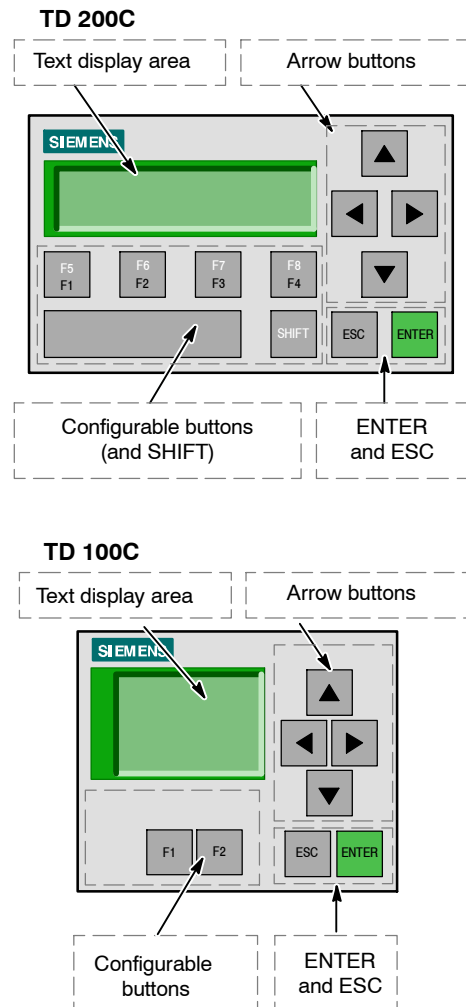

Figure 2-10 Standard TD Keypad for the TD 200C and TD 100C



Tip

On an initial setup for the TD 100C or TD 200C, use the default keypad template shipped with the device to configure baud rates and addresses. Once the TD device has communicated to the CPU, the TD device will use the custom keypad configuration.



Tip

If you are using a custom keypad that does not support the ENTER and ESC buttons, you must use the standard keypad to set up the TD device.

To restore the standard TD keypad:

1. Power down the TD device
2. Press and hold the lower right corner (where ENTER key is located on the standard keypad)
3. Power up the TD device

The default keypad is restored until the TD device is power cycled again.

Using the Keypad Designer to Create a Custom Faceplate for Your TD Device



With the TD 100C and the TD 200C, you can design a custom keypad that incorporates buttons (keys) of varying size, with varying shapes, colors, or fonts that can be layered onto any background image. You can configure up to 14 buttons on the TD 100C and up to 20 buttons on the TD 200C.

The Keypad Designer application allows you to create a custom-designed layout for the keypad of the TD 100C and TD 200C, and also includes samples and templates in the following directories:

- Sample bitmaps for buttons and backgrounds:
C:/Program Files/Siemens/TD Keypad Designer/Images
- Sample projects:
C:/Program Files/Siemens/TD Keypad Designer/Samples
- Templates (for printing multiple copies of the faceplate):
C:/Program Files/Siemens/TD Keypad Designer/Templates

This chapter guides you through the tasks required for creating the layout for the keypad, creating the configuration file for the keypad, and printing the faceplate for the TD 100C and the TD 200C.

You use the configuration file when you are configuring the TD 100C and the TD 200C with the Text Display wizard of STEP 7-Micro/WIN. Refer to Chapter 4 for information about the Text Display wizard.

In This Chapter

Using the Keypad Designer with Other Applications	26
Starting the Keypad Designer	28
Adding Buttons to the Keypad	29
Inserting a Button	29
Modifying the Shape of a Button	29
Defining the Properties of the Button	30
Exporting the Keypad Layout to a Graphics Application	32
Adding a Panel Image to the Faceplate	33
Importing a Panel Image	33
Saving the Keypad to a TD Configuration File	34
Reversing the Panel Image	34
Printing the Panel Image on a Faceplate	35
Printing a Single Faceplate from the Keypad Designer	36
Printing the Faceplate from a Word-Processing Application	37
Installing the Printed Faceplate onto the TD device	38

Using the Keypad Designer with Other Applications

Use the Keypad Designer to create the custom-designed layout for the keypad that incorporates buttons or keys of varying size, with varying shapes, colors, or fonts that can be layered onto any background image. With the TD 200C you can configure up to 20 buttons; with the TD 100C you can configure up to 14 buttons. As shown in Figure 3-1, you use several applications to create a custom keypad:

- Keypad Designer: Creates the layout and the configuration for the keypad
- Third-party graphics application: Designs the graphical appearance of the faceplate
- STEP 7-Micro/WIN (Text Display wizard): Configures the parameter block for the TD device
- Word-processing application (optional): Prints multiple copies of the faceplate

Siemens provides document files (in 6 languages) for Microsoft Word that help you to align the panel images for the perforations on the A4 blank faceplate material. To open these documents, browse to the Templates subdirectory under the Keypad Designer application (C:/Program Files/Siemens/TD Keypad Designer/Templates) and select the template for your TD device and language.

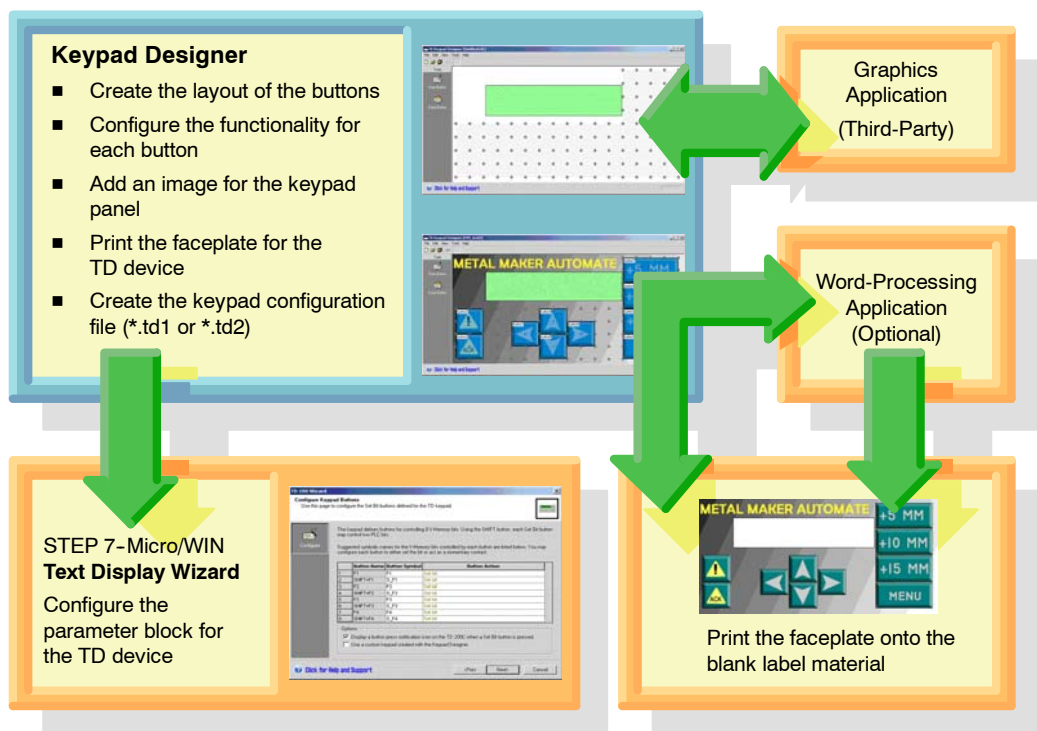

Figure 3-1 Using the Keypad Designer to Create the Custom Faceplate for Your TD Device

As shown in Figure 3-2, you perform the following tasks when designing a custom keypad:

- You use the Keypad Designer to define the layout and the functions for the buttons.
- You export the button template to a third-party graphics application. You then create the panel image by designing the graphical representations for the buttons and the background for the faceplate.
- After you import the panel image into the Keypad Designer, you print the faceplate for the TD device.
- You use the Keypad Designer to create the configuration file (*.td2 for the TD 200C, or *.td1 for the TD 100C).

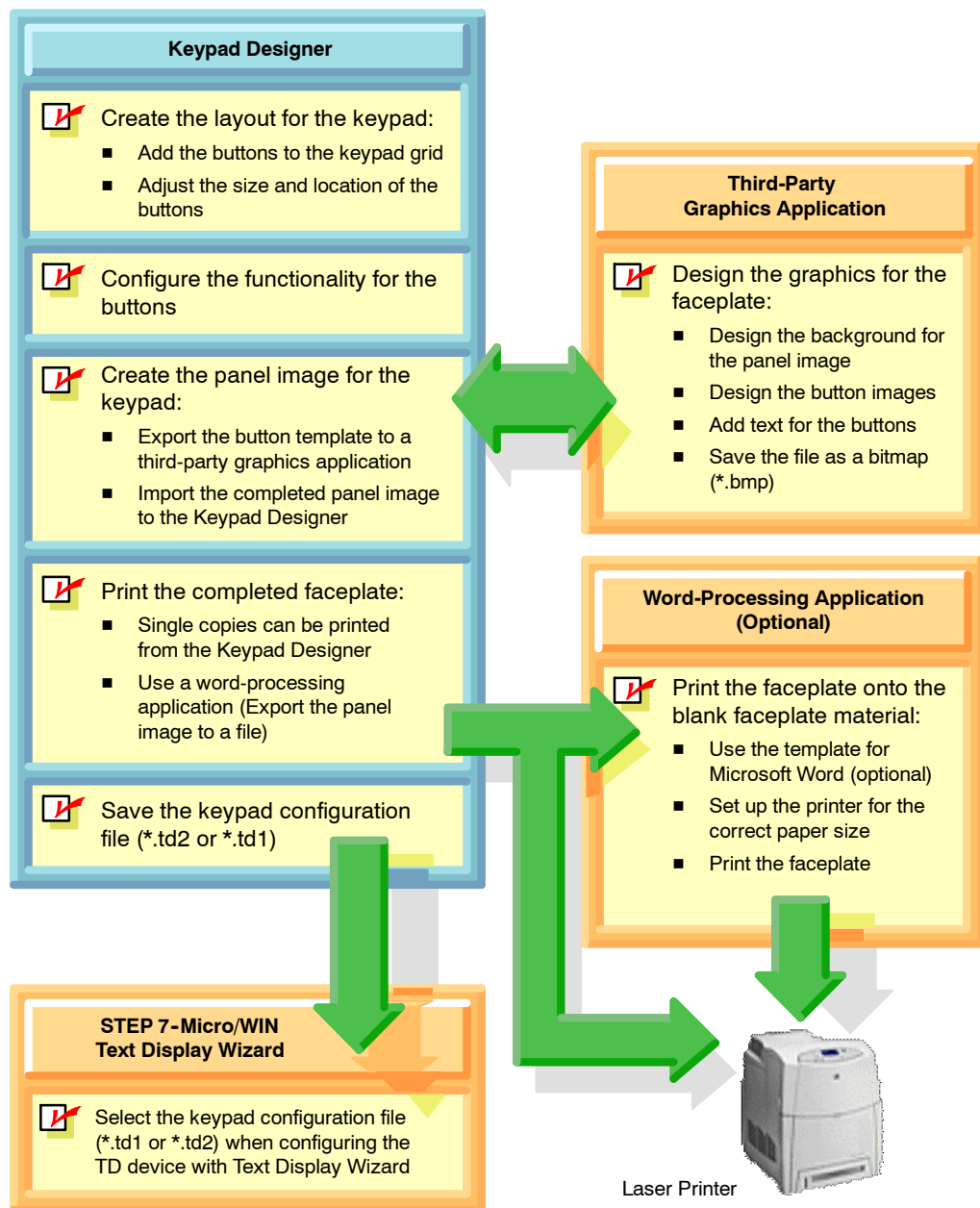

Figure 3-2 Tasks for Creating a Custom Faceplate

Starting the Keypad Designer

You use the Keypad Designer application to create a custom-designed layout for the keypad of the TD 100C or the TD 200C.

When you install STEP 7-Micro/WIN, you also install the Keypad Designer application. The Keypad Designer does not require STEP 7-Micro/WIN.

You can start the Keypad Designer either from within STEP 7-Micro/WIN or as a stand-alone application:

- To start as a stand-alone application: Select the **Start > SIMATIC > TD Keypad Designer** menu command
- To start from STEP 7-Micro/WIN: Click the Keypad Designer icon in the Tools window

The Keypad Designer application opens with a blank keypad template shown in Figure 3-3. Select **File > New** to create a new keypad layout for either the TD 100C or the TD 200C. In the Keypad Designer Type dialog, select the keypad type.

To open an existing project, select the **File > Open** menu command and browse to the project.

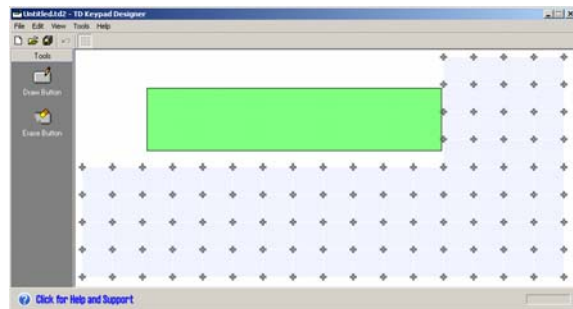

Figure 3-3 Keypad Template

If you open a file with different target (for example, you are working on a TD 200C file, and you open a TD 100C file), the panel workspace resizes for the new target. Since the application is sized based on the panel workspace, you may have to resize and re-position your application framework.

Table 3-1 describes the files that are used by the Keypad Designer.

You can change the language of the Keypad Designer by selecting the **Tools > Options** menu command. You select the language from the Options dialog shown in Figure 3-4.

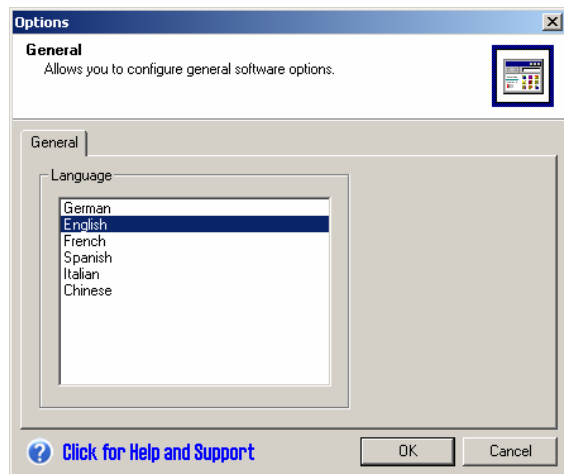

Figure 3-4 Options Dialog

Table 3-1 Files Used by the Keypad Designer

File Type / Command	Extension	Description
TD file Open, Save, Save As	*.td2 (TD 200C) or *.td1 (TD 100C)	Create the Keypad project file that stores the configuration data for the custom-designed keypad (used by the Text Display wizard)
Button Template Export	*.bmp	Export the layout of the buttons on the keypad to a graphics application by selecting a file
Panel Image Import	*.bmp	Import the finished bitmap of the faceplate from the graphics application by selecting a file
Panel Image Export (Optional)	*.bmp	Export the finished faceplate to a word-processing application for printing multiple copies of the faceplate

Adding Buttons to the Keypad

The TD 100C and TD 200C allow you relative freedom when designing your keypad:

- You can configure up to 20 buttons for the TD 200C, and up to 14 buttons for the TD 100C on the TD keypad .
- You can vary the size and the location of the buttons.
- You can define the functionality for each button.

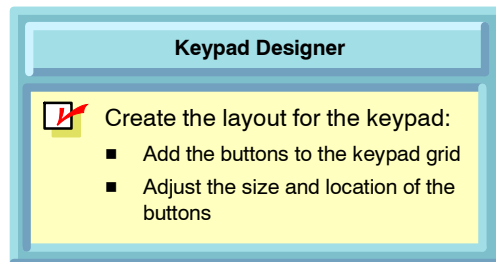

Figure 3-5 Adding the Button to the Keypad

The Keypad Designer provides a grid that aligns the location of the buttons with the physical keypad of the TD device.



Tip

Typically, your keypad design should always include buttons with the following functions: Enter, Escape, Up Arrow, and Down Arrow. These functions allow you to access the pre-configured menus and functions of the TD device.

Inserting a Button

To add a button to the keypad grid:

1. Click the Draw Button icon.
2. Move the cursor over the grid.
3. Move the cursor (and button) into position on the keypad grid.
4. Hold down the left mouse button and drag the cursor to adjust the size and shape of the button.
5. Release the mouse button to insert the button onto the keypad.

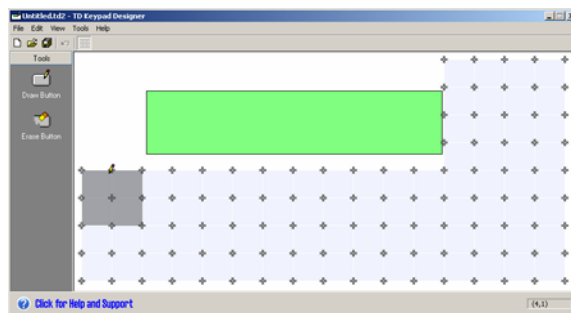

Figure 3-6 Adding a Button

After you have inserted the button onto the keypad grid, you can relocate the button by dragging it to a new location on the grid. However, you cannot resize the button.

Modifying the Shape of a Button

The Keypad Designer provides two methods for modifying the shape of a button:

- Changing the size or shape of a button by adding a second button on top of the first button
- Erasing a portion of the button

Extending the Shape of a Button

You cannot resize a button that has been inserted onto the keypad grid. You can, however, insert a second button on top of the first button to create a new size for the button.

As shown in Figure 3-7, adding a second button also allows you to create buttons of non-rectangular shape (combining the shapes of both buttons).

When you insert the second button, ensure that the cursor is within the boundaries of the first button.

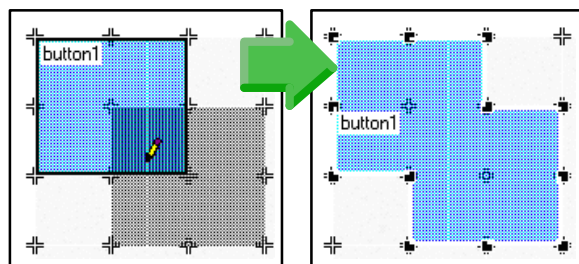

Figure 3-7 Extending the Shape of a Button

Erasing an Area of the Button

You can change the shape of the button by clicking the Erase Button icon.

As shown in Figure 3-8, the Keypad Designer alerts you if the shape of the button is invalid.

To delete the entire button, select the button and press the Delete key.

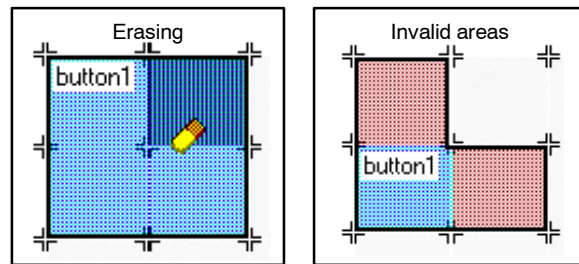

Figure 3-8 Erasing an Area of a Button



Tip

A valid button must consist of at least 4 adjacent cells, with each cell having at least 2 neighbor cells. A neighbor cell must be left, right, or up or down from the cell. Diagonal neighbor cells are not counted.

Defining the Properties of the Button

After you create the button, you define the function that will be performed when an operator presses the button.

You use the Properties dialog to configure the functionality for the button:

1. Select the button to be configured.
2. Select the **Edit > Properties** menu command to display the Properties dialog.

You can also right-click the button and select **Properties** from the context menu. You can double-click the button to bring up the Set Button Properties.

3. Select the function for the button and provide a valid function name. Click OK. See Figure 3-10 for an example of the TD 200C button functions.

Table 3-2 describes the functions that you can configure for the button. The default function is to set a bit in the S7-200 CPU (Set PLC Bit).

Some functions can also be used in combination with other buttons, such as SHIFT or the arrow buttons. The Properties dialog provides suggestions for appropriate buttons for combining the functions.

After you configure the functions for each button on the keypad, select the **File > Save** or the **File > Save As** menu command to create the configuration file (*.td2 for the TD 200C or *.td1 for the TD 100C).



Tip

A button that has been configured will display the button name on the button in the panel layout.

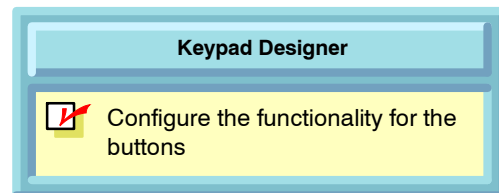

Figure 3-9 Defining the Properties for the Button

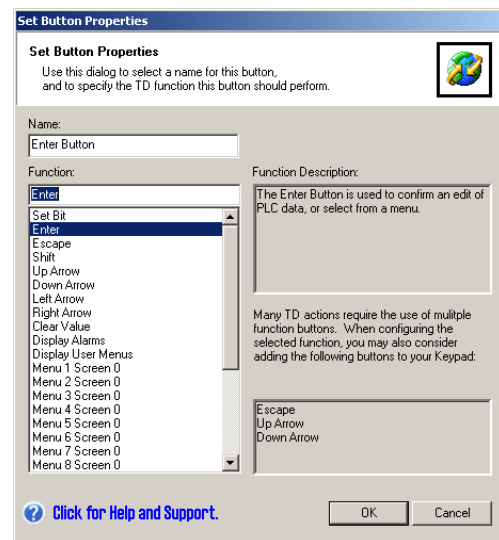

Figure 3-10 Button Properties Dialog

Table 3-2 Button Properties for the TD 100C and TD 200C

Category	Function	Description
Navigation or Selection	Enter	Selects a menu item or confirms a value.
	Escape	Exits from a menu or cancels a selection.
	Up Arrow	Scrolls (upwards) through menu items or increments a value that can be edited.
	Down Arrow	Scrolls (downwards) through menu items or decrements a value that can be edited.
	Left Arrow	Moves the cursor to the left.
	Right Arrow	Moves the cursor to the right.
Entering data	Set Bit	Sets a memory bit in the S7-200 CPU. You use the Text Display wizard to assign the specific bit address. For the TD 200C only, you can use this button to set two different bits by defining the Shift button.
	Shift	Allows you to use one Set PLC Bit button to control two different bits in the S7-200 CPU. (TD 200C only)
	Clear Value	Sets the value being entered to zero (0).
	Edit V-Memory	Edits a V memory location in the S7-200 CPU. You must specify the address for the V memory at run time. (TD 200C only)
User Screens and Alarms (User menu or Alarms menu) See Chapters 4 and 5	Menu Mode	Displays the standard TD menus (See Chapter 5)
	Display Alarm	Displays the current alarm message(s)
	Display User Menus	Displays the user menu.
	Menu 1 Screen 0	Displays the first user screen in the first user menu.
	Menu 2 Screen 0	Displays the first user screen in the second user menu.
	Menu 3 Screen 0	Displays the first user screen in the third user menu.
	Menu 4 Screen 0	Displays the first user screen in the fourth user menu.
	Menu 5 Screen 0	Displays the first user screen in the fifth user menu. (TD 200C only)
	Menu 6 Screen 0	Displays the first user screen in the sixth user menu. (TD 200C only)
Menu 7 Screen 0	Displays the first user screen in the seventh user menu. (TD 200C only)	
Setting up the TD 200C (Operator menu) See Chapter 5	CPU Status	Displays the View CPU Status screen. Reads and displays the status of the S7-200
	Select Language Set	Displays the Set Language screen, allowing you to switch between the languages that you configured for the TD 200C. (TD 200C only)
	Set PLC Time and Date	Displays the Set Time and Date screen, allowing you to enter the time and date.
Diagnostics (Diagnostic Menu) See Chapter 5	Change PLC Mode	Displays the Change CPU Mode screen, allowing you to change the operating mode of the S7-200. (TD 200C only)
	Edit Memory	Displays the Edit CPU Memory screen. (TD 200C only)
	Force I/O	Displays the Force I/O screen. (TD 200C only)
	Program Memory Cartridge	Displays the Make MC screen, allowing you to copy the user program to the memory cartridge. (TD 200C only)
	TD Setup	Displays the TD Setup screen.
View Messages	View Messages	Displays the View Messages screen. (TD 200C only)
	Release Password	Allows you to immediately restore the password-protection for the TD 100C and TD 200C.

Exporting the Keypad Layout to a Graphics Application

After you have configured the buttons on the keypad, you can create the graphical representation for the faceplate. You can use any third-party graphics application to add colors, lines and other artwork to the panel design.

The Keypad Designer exports the layout of the buttons as a bitmap file (*.bmp) that you edit with the graphics application.

As shown in Figure 3-12, the button template provides a bitmap image of the layout of the keypad that you can use with your graphical application to position, size and align the graphical elements of your faceplate design. These elements can include logotype, text, or other images.

The Keypad Designer allows you to export the layout of the buttons into your graphics application. Use the **File > Export > Button Template to File** menu command to create a bitmap file (*.bmp) that you insert into the graphics application.

After you customize the layout (adding background image, colors, buttons or logotype), you save the file as a bitmap (*.bmp). This bitmap becomes the panel image for the Keypad Designer.

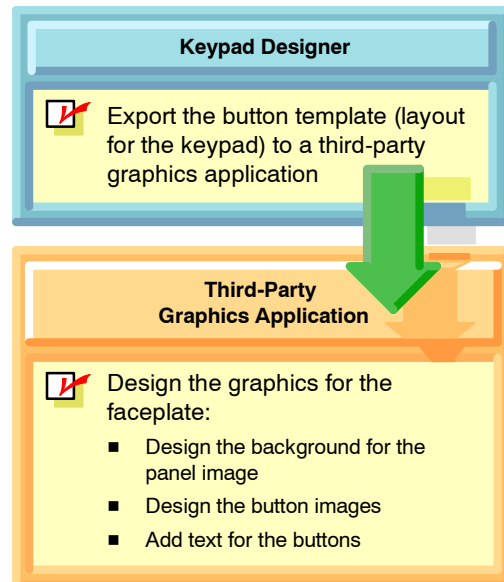

Figure 3-11 Creating the Panel Image: Export Button Layout



Tip

When designing the colors for your panel image, remember that any white area will be printed as transparent (clear).

Keypad Layout
(in the Keypad Designer)

Button Template
(exported to a graphics application)

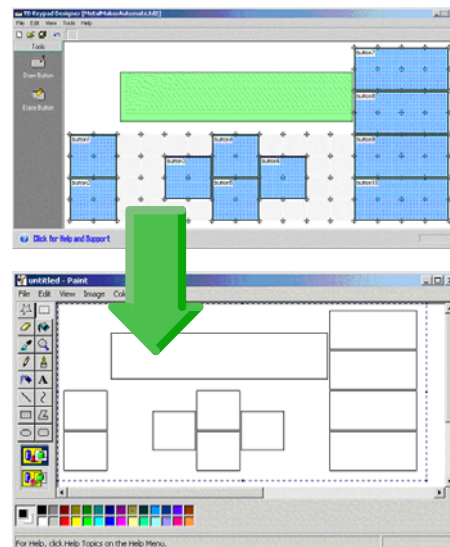

Figure 3-12 Exporting the Button Template to a Graphics Application

Adding a Panel Image to the Faceplate

Using your own graphics application, you create the following graphical elements for the faceplate of the TD 100C or the TD 200C:

- Button images
- Background image or color scheme
- Text (for the buttons or the background)
- Logotypes (and other images or text)

You are not required to use square buttons. However, you must ensure that your button design covers the area of the button as defined in the button template.

After you have used your graphics application to modify the panel image for the faceplate, save the design as a bitmap file (*.bmp).

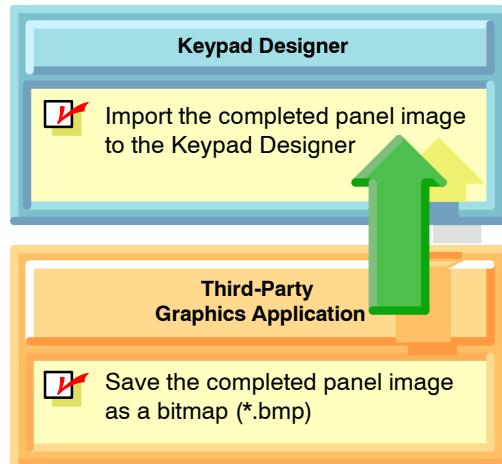

Figure 3-13 Creating the Panel Image: Import Panel Image

Importing a Panel Image

When you have completed the graphical design of panel image for the faceplate, you import the panel image back into the Keypad Designer.

After you open your keypad project (*.td1 or *.td2), use the **File > Import > Panel Image from File** menu command to select the bitmap file that you created with your graphics application.

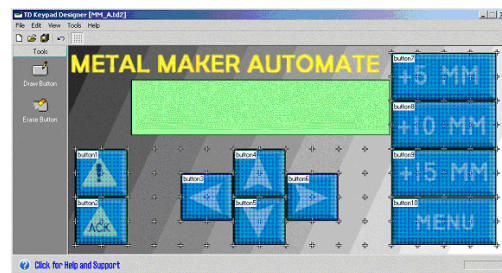

Figure 3-14 Keypad with a Panel Image



Tip

When you design your faceplate, you can create the bitmap with any resolution. However, the size of the background image for the TD device must exactly match the following dimensions:

- For the TD 200C:

Width:	137 mm (+/- 0.15 mm)	(5.42 inches)
Height:	65.7 mm (+/- 0.15 mm)	(2.58 inches)
- For the TD 100C:

Width:	79 mm (+/- 0.1 mm)	(3.11 inches)
Height:	65.8 mm (+/- 0.1 mm)	(2.59 inches)

If your faceplate design does not match these dimensions, the Keypad Designer alerts you before importing the panel image. If you import a panel image with incorrect dimensions, the Keypad Designer resizes your panel image, which could distort the appearance of your faceplate design.

Saving the Keypad to a TD Configuration File

When you save the keypad, you create a TD configuration file (*.td1 for the TD 100C, and *.td2 for the TD 200C). This file contains the following information about the buttons on the keypad:

- Number of buttons
- Location and sizes of the buttons
- Names of the buttons
- Functions assigned to the buttons
- Panel image (if one was imported)

Use the **File > Save** or **File > Save As** menu command to save the configuration of the keypad.

The Text Display Wizard uses this information for configuring the TD 100C or TD 200C. See Chapter 4 for more information.

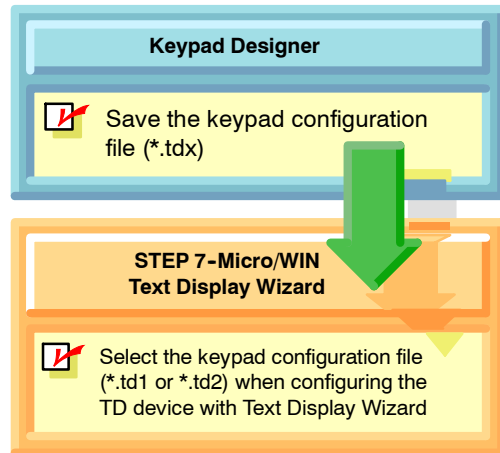

Figure 3-15 Saving the TD Configuration File



Tip

The Keypad Designer allows you to save invalid or incomplete configurations. This allows you to save interim versions of your work. However, always ensure that the final configuration of the keypad is valid and complete before using the configuration file (*.tdx) with the Text Display wizard.

Reversing the Panel Image

The Reverse Panel Image option only affects the way that the panel image is saved to a file using the **File > Export > Panel Image to File** menu command. The exported bitmap file can then be inserted into the Microsoft Word template. For more information see the next section, Printing the Panel Image on a Faceplate. The Reverse Panel Image option does not change the layout of the keypad.

- Printing a reversed image allows you to orient the side of the faceplate with the ink from the printing process towards the TD device. The operator then touches only the plastic membrane and not the ink when pressing a button. See Figure 3-16.
- Printing a non-reversed panel image allows the elements to be read correctly when printed. Use the non-reversed panel image when you print a paper copy of the faceplate for review. See Figure 3-17.

Use the **File > Export > Reverse Panel Image** menu command to select this function. A check mark notifies you that Reverse Panel Image function is selected.

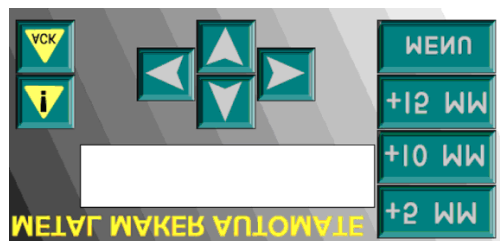

Figure 3-16 Reversed Panel Image

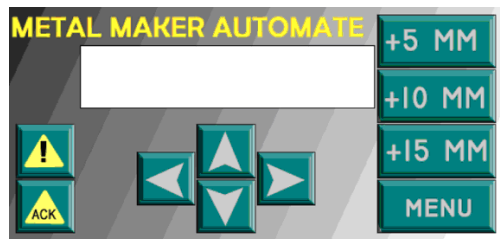

Figure 3-17 Non-Reversed Panel Image

Printing the Panel Image on a Faceplate

To print your custom-designed panel image onto the blank faceplate material, you must use a laser printer that supports printing transparency material in both the A4 and envelope formats and also supports color printing.

- You can print a single panel image directly from the Keypad Designer on the envelope-sized blank faceplate (shipped with the TD device). When you print a single faceplate (**File > Print**), the panel image is always reversed.
- To print multiple panel images, you can use the Microsoft Word template that ensures your panel image design is properly sized. You can print multiple panel images onto the perforated A4-size blank faceplate sheets. See Appendix A for order numbers.



Tip

The faceplate material is specially treated on one side to accommodate printing with a laser printer. The treated surface is up (or toward you) when you are holding the material with the cut corner in the top right of the sheet.

Ensure that the material is correctly inserted into the laser printer so that the panel image is printed onto the treated surface of the material. You must print a reversed-panel image version onto the faceplate material. To reverse the panel image, see the previous section, *Reversing the Panel Image*.

Before printing your panel image onto the blank faceplate sheet, first test your design by printing the panel image onto regular paper. You can then temporarily use the paper faceplate to test the functionality of the design with your TD device.

Using the blank faceplate sheets also allows you to create large quantities of high-quality faceplates by utilizing the professional printing services of shops that specialize in laser printing.

You can order additional blank faceplates in perforated A4-size sheets (10 sheets/package). The faceplate material is especially designed for printing with laser printers.

The blank faceplate material is available in two sizes:

- Envelope size for printing a single faceplate: The Keypad Designer prints registration lines for trimming the faceplate to the correct dimensions. (Use a metal straight edge and a knife or razor blade to ensure accurate and straight cuts.) The TD device ships with a single blank faceplate.
- A4 size (210 mm x 297 mm) for printing multiple copies of the faceplate: You can use the Microsoft Word template to print the faceplate onto perforated areas of the material. You do not have to cut the faceplates from the material. Order these A4 sheets from your Siemens distributor. See Appendix A for order numbers.

The diagram illustrates two methods for printing a faceplate, presented as boxes with a light blue border and a light yellow background.

Keypad Designer

- Print a single faceplate from the Keypad Designer
- Print multiple faceplates (from a word-processor application):
 - Export the panel image
 - Paste or insert the panel image into your word-processing application

Word-Processing Application (Optional)

- Print the faceplate onto the blank faceplate material:
 - Use the template for Microsoft Word (optional)
 - Set up the printer for the correct paper size
 - Print the faceplate

Figure 3-18 Printing the Faceplate

**Tip**

Before attempting to print a custom faceplate, ensure that both the printer and the word-processing application are set to the correct paper size:

- Single-copy sheet: Set both the printer and word-processing application to print on Envelope.
- Multiple-copy A4 sheet: Set both the printer and the word-processing application to print on A4-size paper.

Your computer and your laser printer may have other settings that cause the printer to scale the faceplate to an incorrect size. Always first print a test copy on paper before printing your faceplate onto the blank material.

Printing a Single Faceplate from the Keypad Designer

You can print individual faceplates directly from the Keypad Designer:

1. Ensure that the laser printer is set to print envelopes.
2. Insert the envelope-size faceplate material into the tray.
3. Select the **File > Print** menu command.
4. Select the laser printer and click OK.
5. Using the cut lines and a paper cutter, cut the faceplate from the material.

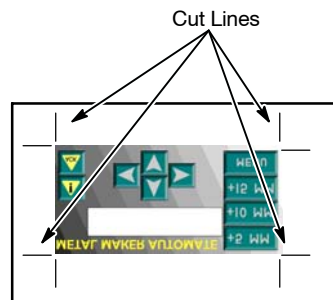

Figure 3-19 Printing a Single Faceplate

**Tip**

For best results use a razor-blade cutting knife with a metal straight edge to cut the faceplate from the material. You can also use a high-quality paper cutter. Be especially careful when using scissors or similar tools. Scissors are more likely to stretch or tear the material, causing irregular edges for the faceplate.

Printing the Faceplate from a Word-Processing Application

You use a word-processing application (such as Microsoft Word) to print multiple copies of the faceplate onto A4-size blank faceplate material. After you export the panel image of the faceplate into a document, you adjust the location of the panel images and print the document.



Tip

Siemens provides document files (in 6 languages) for Microsoft Word that helps you to align the panel images for the perforations on the A4 blank faceplate material. To open these documents, browse to the Templates subdirectory under the Keypad Designer application (C:/Program Files/Siemens/TD Keypad Designer/Templates) and select the template for your TD device and language.

Before printing the faceplate onto the blank faceplate material, you must ensure that the document and the printer settings are both set to print on A4 paper. Also, ensure that the laser printer itself is configured to print A4 paper.

After you print the faceplate document, you use the perforations to remove the faceplates from the sheet.

To export the panel image to your word-processing application:

1. Open your word-processing application (Microsoft Word) and open the template file.
2. Open the Keypad Designer.
3. In the Keypad Designer, select the **File > Export > Panel Image to File** menu command to create a bitmap file that you insert into the word-processing application.
4. Insert the panel image into the document by using the word-processing application to insert the bitmap file (*.bmp) that you created with the Keypad Designer.
5. Follow the instructions in the template file for positioning and sizing the faceplate.
6. After inserting the panel image into the document, save the document using the **File > Save As** menu command of the word-processing application.

With the panel images saved in your document, you can print the document to your laser printer.



Tip

Before printing the panel image onto the blank faceplate material, first test your design by printing the faceplate onto regular A4 paper.

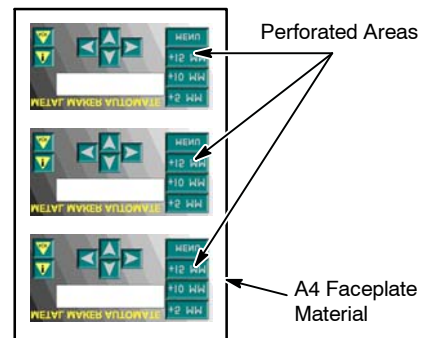

Figure 3-20 Printing Multiple Faceplates

Installing the Printed Faceplate onto the TD device

Use the following procedure to install your faceplate on the TD device. The example shown here is for the TD 200C. Installing a faceplate on a TD 100C is similar; the differences are noted.

1. Remove the blue protective covering over the display of the TD device.
2. As shown in Figure 3-21, remove the strip of protective paper on the left side of the TD 200C to expose a strip of the adhesive. For the TD 100C, this strip is on the right side of the device.
3. Carefully align your custom faceplate on the entire TD 200C, and then seal the faceplate to the exposed adhesive by pressing down on the left side of the faceplate. For the TD 100C press down on the right side of the faceplate.
4. Carefully lift back the unadhered faceplate and remove the rest of the protective paper from the TD device.
5. Carefully position the faceplate onto the TD device. Firmly press the faceplate onto the adhesive, taking care to remove any air bubbles that may have been trapped underneath.

Refer to Chapter 2 for additional information about installing the TD devices, including the dimensions for the faceplate.

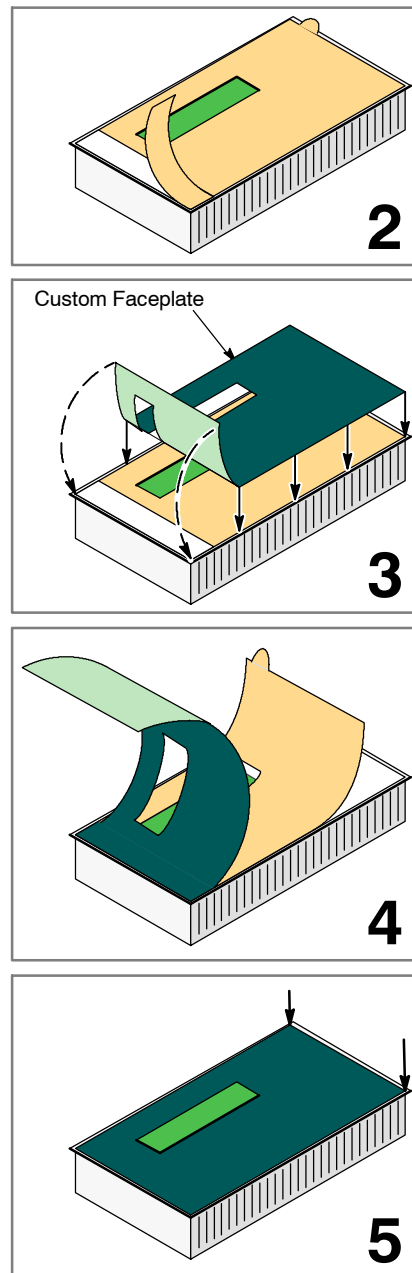

Figure 3-21 Adhering the Faceplate onto the TD Device

Using the Text Display Wizard to Configure the S7-200 CPU for Your TD Device

4

You do not configure or program the TD device. The Text Display wizard creates a parameter block that stores the configuration, screens and alarms for the TD device. The S7-200 CPU stores the parameter block in V memory. At power-up, the TD device reads the parameter block from the S7-200 CPU.

You use the Text Display wizard of STEP 7-Micro/WIN to perform the following tasks:

- Configuring the parameters for the TD device
- Creating the screens and alarms to be displayed on the TD device
- Creating the language sets for the TD device (TD 200C and TD 200 only)
- Assigning the V memory address for the parameter block



Tip

To connect your TD device to a network, you use the Diagnostic or TD Setup Menu of the TD device to set up the network addresses, baud rate and other parameters. Refer to Chapter 5.

In This Chapter

Overview of the Configuration Tasks	40
Configuring the TD Device	42
Task Overview	42
Starting the Text Display Wizard for the TD Device	43
Selecting the Type of TD Device to Configure	43
Selecting a Password for the TD Device	44
Enabling the TD Menu Functions	44
Selecting the Update Rate for the TD Device	46
Selecting the Language and the Character Set	46
Selecting the Font Size (TD 100C only)	47
Loading a Custom Keypad (TD 100C and TD 200C Only)	47
Configuring the Buttons on the Keypad	48
Configuring the Screens for the TD Device	49
Creating the User Menu	50
Creating the Text for a Screen	51
Embedding a Variable into the Text of a Screen	51
Configuring the Alarms	54
Determining the Type of Operator Interaction for an Alarm	55
Setting the Default Display Mode and Alarm Parameters	56
Entering the Text for an Alarm	57
Embedding a Variable into the Text of an Alarm	57
Configuring the Language Sets for the TD Device (TD 200C, TD 200 only)	59

Overview of the Configuration Tasks

The S7-200 CPU stores the configuration data for the TD device, including the screens and alarms, into a parameter block (located in V memory). The Text Display wizard creates the parameter block. When you download your project (user program and data block) to the S7-200 CPU, you also download the parameter block as part of the data block.

You do not configure or program the TD device. At power-up, the TD device reads the parameter block from the S7-200 CPU.

As shown in Figure 4-1, you use the Text Display wizard of STEP 7-Micro/WIN to create the parameter block for the TD devices. Figure 4-2 shows the sequence of the tasks required for configuring the parameters of the TD device.

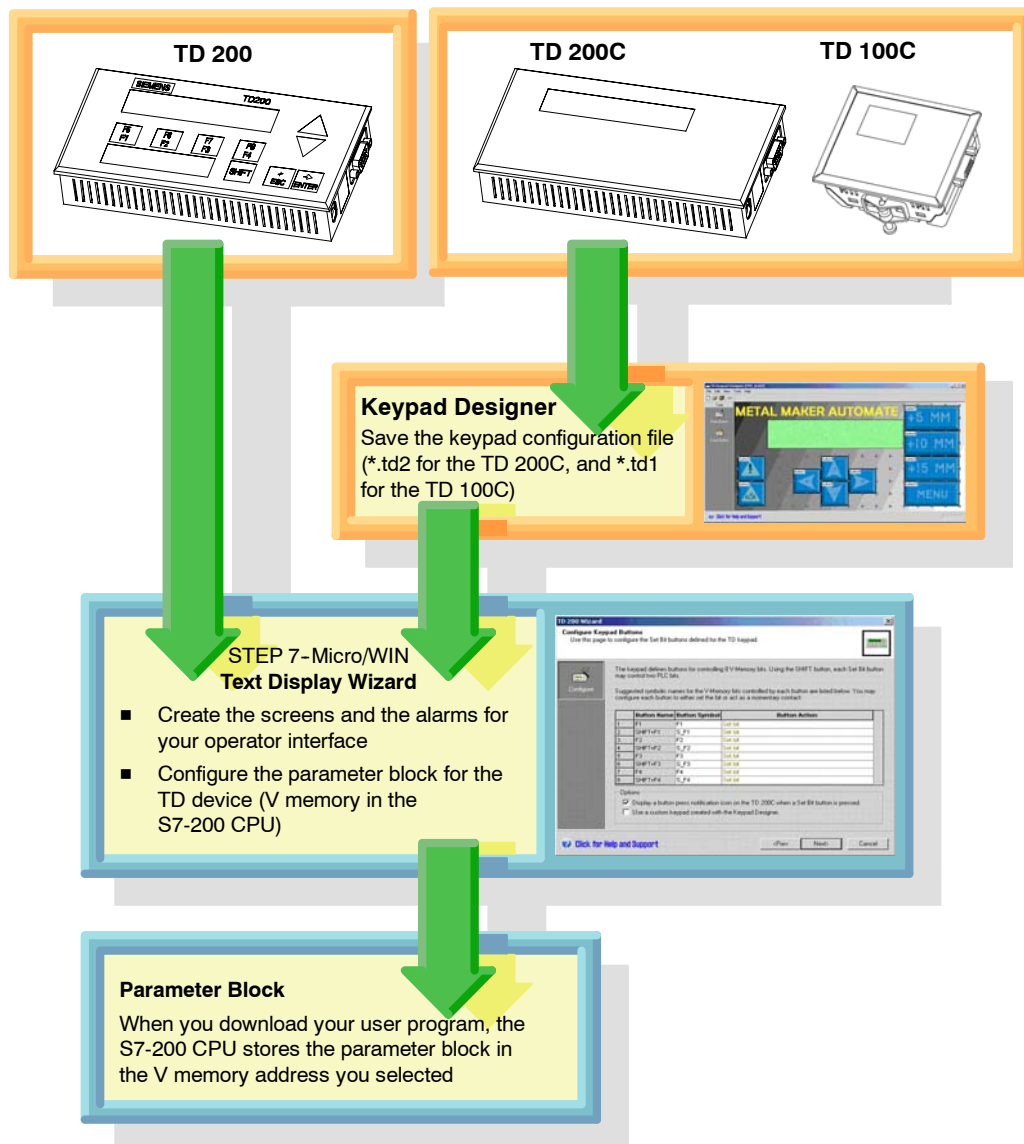

Figure 4-1 Using the Text Display Wizard to Configure the TD Device

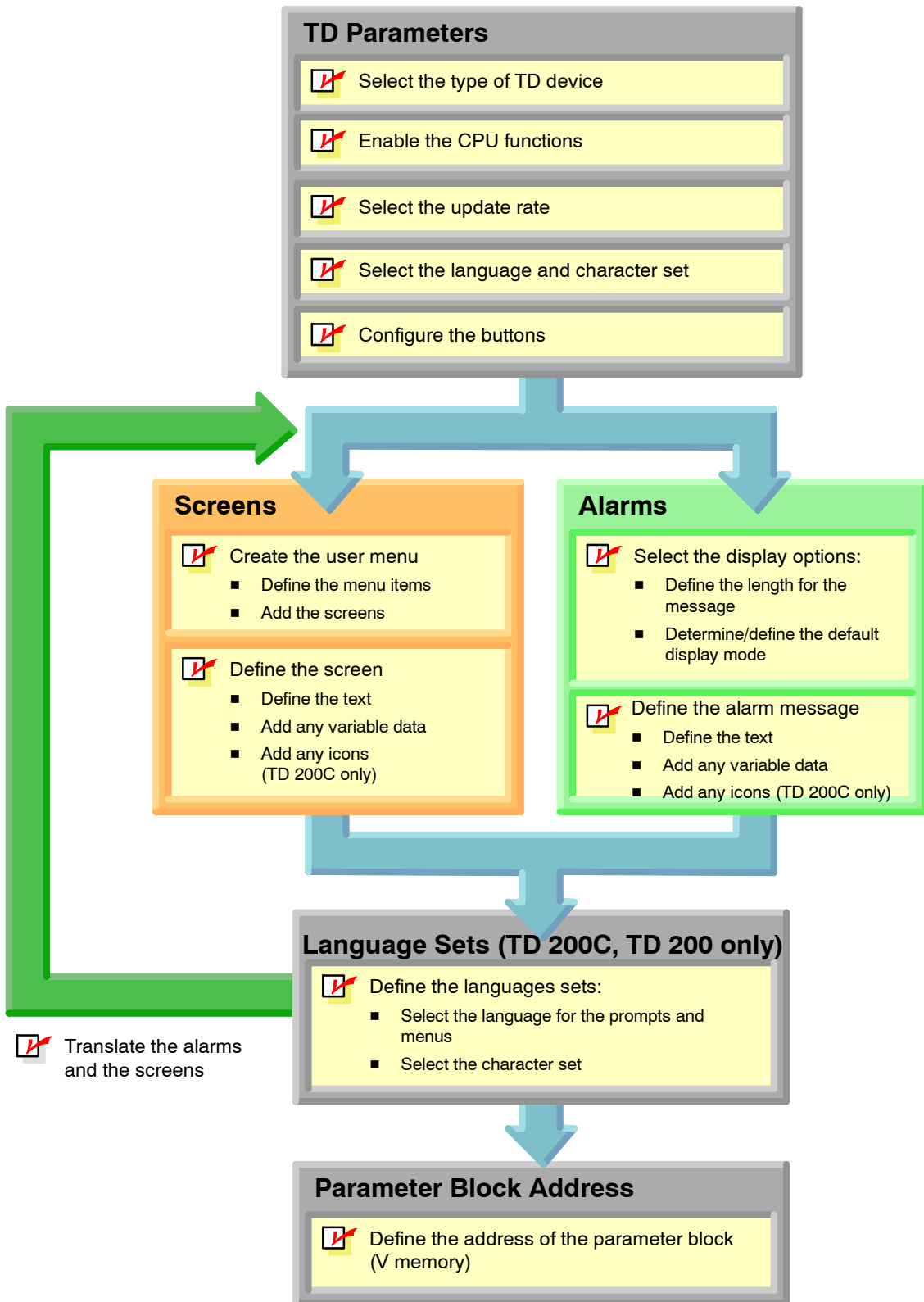

Figure 4-2 Configuration Tasks of the Text Display Wizard

Configuring the TD Device

STEP 7-Micro/WIN provides a wizard that makes it easy to configure the parameter block and the messages in the data memory area of the S7-200 CPU.

Task Overview

As shown in Figure 4-3, the Text Display wizard performs the same basic tasks for configuring the TD devices. However, the specific selections reflect the differences between the TD devices.

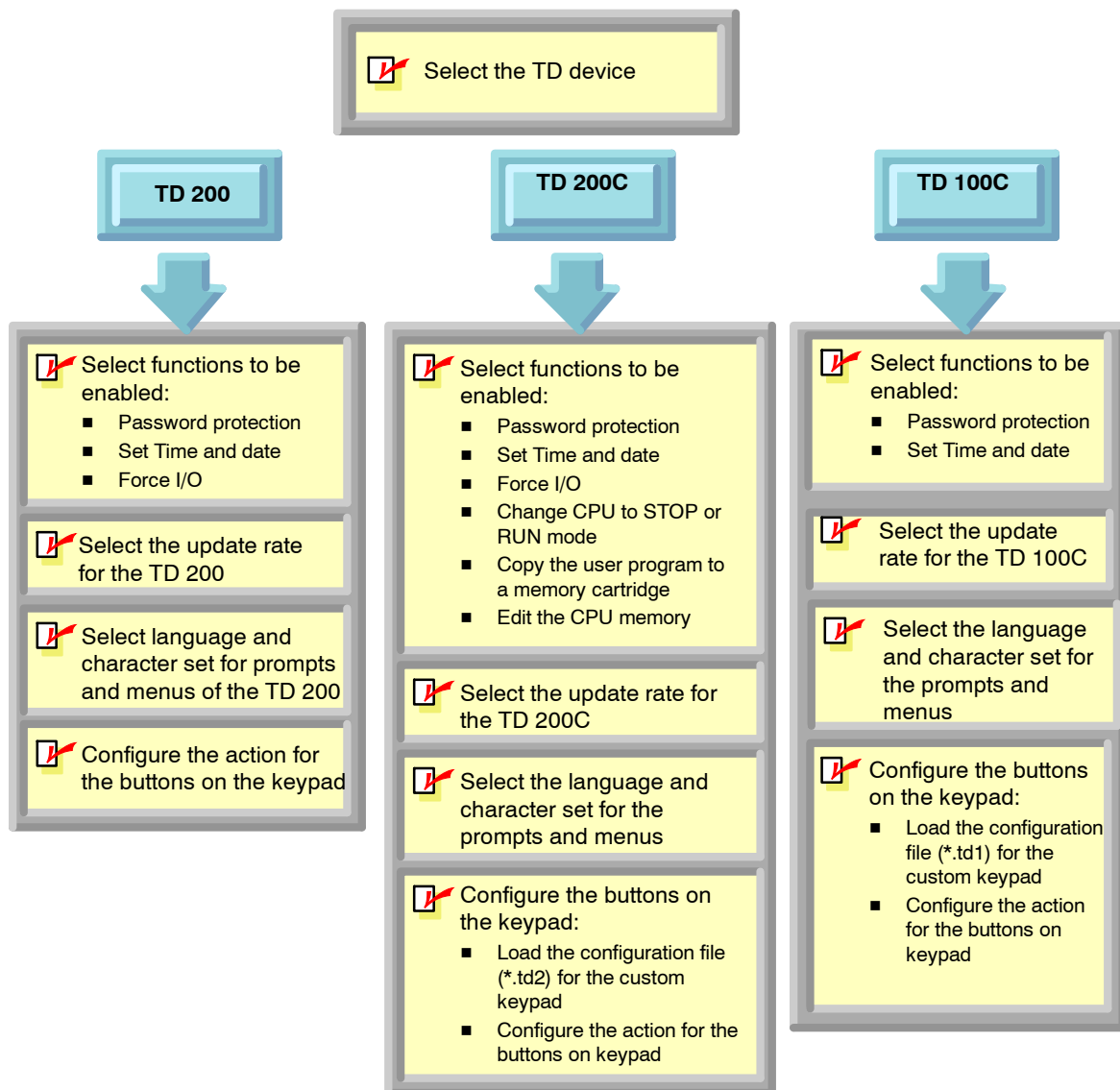

Figure 4-3 Tasks Required for Configuring the Parameters of the TD Device

Starting the Text Display Wizard for the TD Device

You use the Text Display wizard to configure the parameters for the TD device. You can also use the Text Display wizard to modify an existing TD configuration.

To open the Text Display wizard:

1. Start STEP 7-Micro/WIN.
2. Select the **Tools > Text Display Wizard** menu command.

The Text Display wizard displays the Introduction dialog, as shown in Figure 4-4.

If the Text Display wizard finds an existing TD configuration, the Introduction dialog provides a list of existing TD configurations and allows you to select a TD configuration to modify.

Use the Next button to proceed through the dialogs of the wizard.

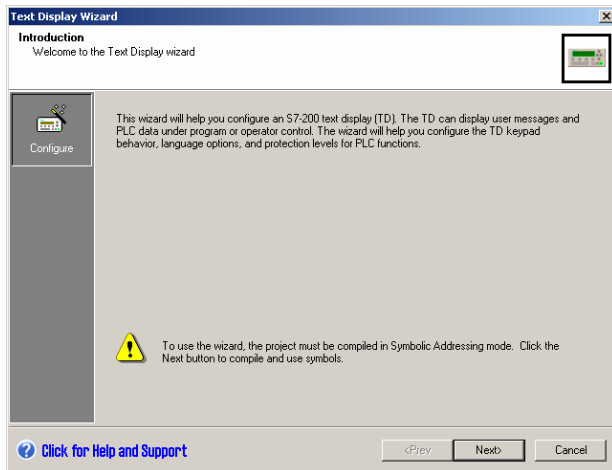

Figure 4-4 Text Display Wizard

Selecting the Type of TD Device to Configure

As shown in Figure 4-5, the Text Display wizard prompts you to select the type of TD device to be configured.

The Text Display wizard uses this selection to display the dialogs for configuring the parameters for your specific TD device.

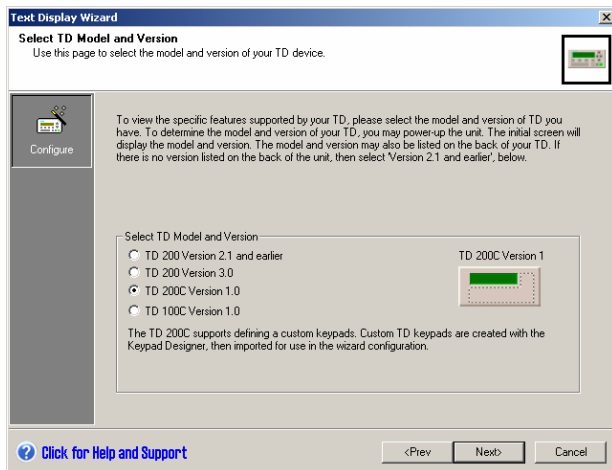

Figure 4-5 Selecting the TD Device

Selecting a Password for the TD Device

Selecting a password for the TD device helps you to protect the security of your process or application. By enabling a four-digit password (from 0000 to 9999), you can control access to the S7-200 CPU by requiring that an operator enter the password before editing variables from the TD device.

The TD password also restricts access to the following TD functions:

- Set time and date
- TD Setup
- Forcing I/O
- Changing the CPU mode
- Creating a memory cartridge
- Editing CPU memory



Tip

The TD password affects only the ability of an operator to use the TD device for certain functions.

If your S7-200 CPU is configured to require a password, the operator must enter the CPU password to force I/O and create a memory cartridge. The TD password is used in addition to the CPU password.

Enabling the TD Menu Functions

You can select the TD functions that appear on your TD device menu. The TD devices have different functions available. Refer to Chapter 5 for information about these CPU functions.

TD 200

Select the functions you want to appear on the TD 200 menus. The TD 200 supports the following functions:

- Setting the Time-of-Day clock:** Allows you to set the time and date for the S7-200 CPU
- Forcing I/O:** Allows you to force I/O points in the S7-200 CPU to be on or off

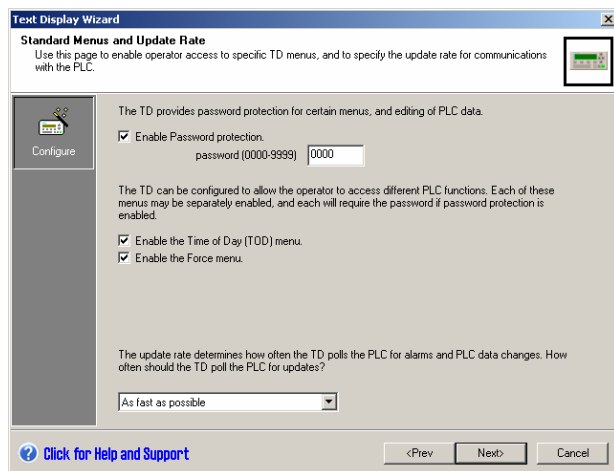

Figure 4-6 Enabling the CPU Functions for the TD 200

TD 200C

Select the functions you want to appear on the TD 200C menus. The TD 200C supports the following functions:

- Setting the Time-of-Day clock: Allows you to set the time and date for the S7-200 CPU
- Forcing I/O: Allows you to force I/O points in the S7-200 CPU to be on or off
- Creating a memory cartridge: Allows you to create a memory cartridge which is a complete copy of the CPU
- Changing the operating mode: Allows you to set the S7-200 CPU to STOP or RUN
- Editing the CPU memory: Allows you to view and change the values of the data stored in the S7-200 CPU

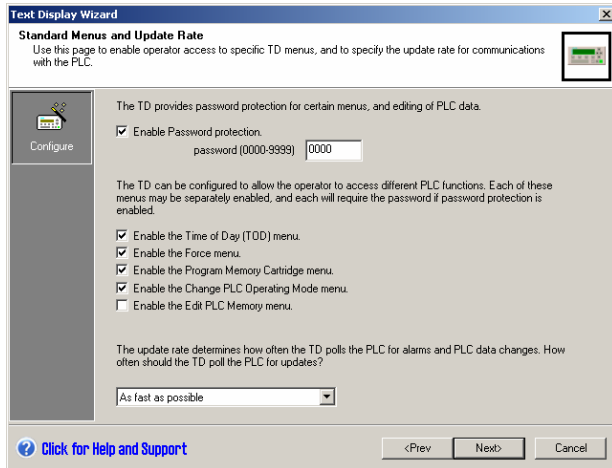

Figure 4-7 Enabling the CPU Functions for the TD 200C

TD 100C

Select the function you want to appear on the TD 100C menus.

The TD 100C supports the Setting the Time-of-Day clock function. This function allows you to set the time and date for the S7-200 CPU function.

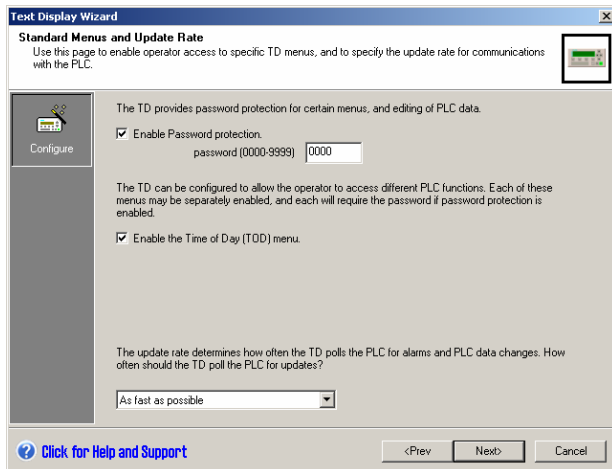

Figure 4-8 Enabling the CPU Functions for the TD 100C

Selecting the Update Rate for the TD Device

You can select how often the TD device performs a read operation to update the information from the S7-200 CPU. You can select from "As fast as possible" to "Every 15 seconds" (in one-second increments).

Selecting the Language and the Character Set

The Text Display wizard allows you to select the language for the system menus and prompts of the TD device. This selection does not affect the language setting for the screens or alarms that you enter. You select a character set that supports the language of the text that you enter for the screens and alarms. (If the character set does not match the Windows character set, the Text Display wizard may not display the characters correctly. The TD device displays these characters correctly.)

- Select the language for the system menus and prompts displayed by the TD device.

The TD device supports English, French, German, Italian, Simplified Chinese, and Spanish.

- Select the character set for the text in your alarms and screens.

Refer to Appendix A for descriptions of the character sets supported by the TD device. The *Simplified Chinese Character Set* is an electronic file that resides on the STEP 7-Micro/WIN documentation CD.

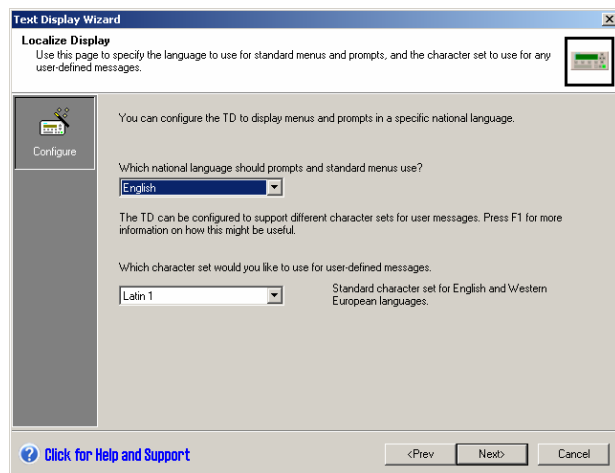

Figure 4-9 Localizing the TD Device

These settings define a language set for the TD device. The Text Display wizard also provides a series of dialogs for copying the alarms and screens to create additional language sets (TD 200C and TD 200 only). For each language set, you select the language and the character set.



Tip

When you create multiple language sets (TD 200C and TD 200 only), the Text Display wizard copies the alarms and screens from the primary language set to the other language set. You then edit the screens and alarms to translate the text displayed for the new language set.

If you need to modify the screens or messages (such as to add a new variable or to add a new alarm), you must edit the primary language. The Text Display wizard copies these changes to the other language sets.

The Text Display wizard only allows you to change the text in the other language sets.

Selecting the Font Size (TD 100C only)

For all character sets except Simplified Chinese, the TD 100C supports two font sizes for displaying user messages. Larger fonts are easier to read, but will result in fewer characters per user message. The following font sizes are available:

- Small font (16 characters per line)
- Large font (12 characters per line)

The Simplified Chinese character set displays 8 Chinese characters per line.

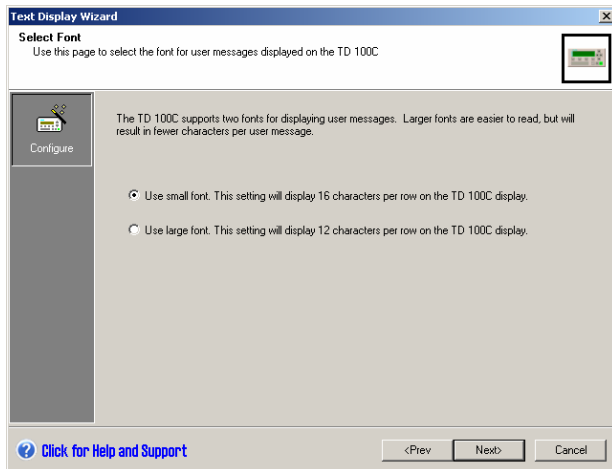

Figure 4-10 Selecting the Font Size (TD 100C)

Loading a Custom Keypad (TD 100C and TD 200C Only)

The TD 100C and TD 200C allow you to create a custom keypad. As described in Chapter 3, you can insert buttons onto the keypad. The Keypad Designer saves this configuration to a file (*.td1 for the TD 100C and *.td2 for the TD 200C).

To load the keypad configuration file into the Text Display wizard:

1. Select the option, Use a custom keypad created with the Keypad Designer. (Find this check box in the Options area of the Configure Keypad Buttons dialog. See Figure 4-11.)
2. Browse to the keypad configuration file (*.tdx) that you created with the Keypad Designer.

The Text Display wizard loads the keypad configuration file and updates the table of buttons and the button symbols.

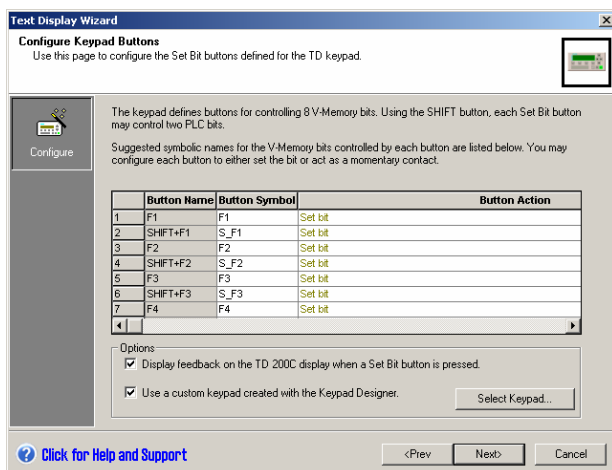

Figure 4-11 Configuring the Functions for the Buttons

The Text Display wizard lists only those buttons that you had defined with the Set Bit functionality when you created the buttons with the Keypad Designer.

Configuring the Buttons on the Keypad

As shown in Figure 4-11, the Configure Keypad Buttons dialog allows you to select a symbol name and an action for each of the configurable buttons on the TD device.

- The TD 200 keypad provides 4 configurable buttons and a SHIFT button that can be configured for up to 8 bits in the S7-200 CPU
- The TD 200C can be configured for up to 20 configurable buttons
- The TD 100C can be configured for up to 14 configurable buttons



Tip

The Configure Keypad Buttons dialog of the Text Display wizard displays only those buttons that set bits in the S7-200 CPU. The Text Display wizard does not list the buttons with other functionality, such as ESC or SHIFT.

The symbols that you assign to the buttons on the keypad allow the logic of your user program in the S7-200 CPU to interact with the TD device. (The Text Display wizard suggests a symbol for these buttons. You can accept the recommendation or enter a new symbol for the button.)

For each button, you configure the type of action:

- Set bit:** When you press the button on the TD device, the TD device sets the bit on in the S7-200 CPU. The bit stays on until the logic of your user program in the S7-200 CPU resets the bit.
- Momentary contact:** When you press the button on the TD device, the TD device sets the bit on in the S7-200 CPU. When the TD device button is released, the TD device turns the bit off in the S7-200 CPU.



Tip

The TD device only sets the bit on or off in the S7-200 CPU a single time when the TD device button is either pressed or released.



Tip

The TD devices can display a special icon on the display to provide visual feedback to the operator that the key was pressed on the bit set in the CPU. Check the box at the bottom of the Configure Keypad Buttons wizard screen to enable this feature (see Figure 4-11).

Configuring the Screens for the TD Device

The TD device supports a set of user-defined screens and a user menu. Screens allow the operator using the TD device to initiate the interaction with the S7-200 CPU.

- ❑ **User menu:** Provides a hierarchy for switching between groups of screens. For the TD 200C and the TD 200 you configure up to 8 entries in the user menu. For the TD 100C, you configure up to 4 entries in the user menu.
- ❑ **Screens:** You create up to 8 screens for each entry in the user menu.

The TD device displays the screens and the items on the user menu in the order that you configure them.

If you configure both alarms and screens, you also designate the default display mode for the TD device.

The operator uses the buttons on the keypad to navigate through the user menu or the screens that you configured.

Figure 4-13 shows the buttons that a TD operator could use to navigate from a user menu to the screens associated with that item in the menu.

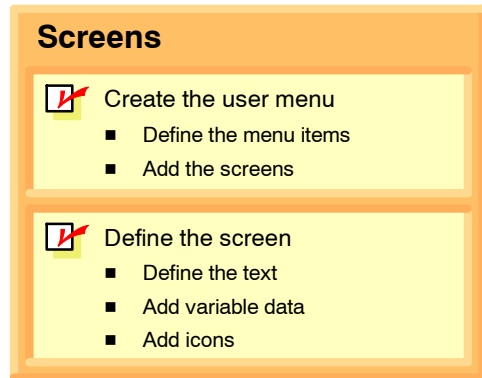

Figure 4-12 Configuring the Screens

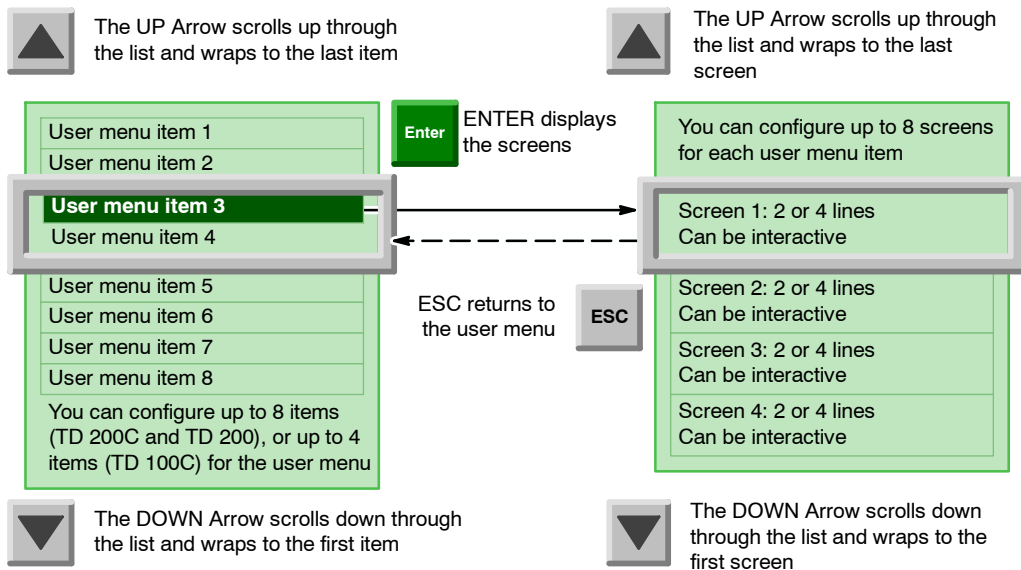

Figure 4-13 Navigating through a Hierarchy of User-Defined Screens



Tip

The screens in the TD 200 and TD 200C are always two lines, and the screens in the TD 100C are always 4 lines.

After you have configured the TD device, you can configure the screens and the user menu. Click the user menu icon to start creating the user menu for the screens. See Figure 4-14.

For the user menu, you perform the following tasks:

- Create the groups (names) to be displayed on the user menu
- Determine the sequence of the groups listed on the user menu

For the screens, you perform the following tasks:

- Add the screens to each group (on the user menu)
- Create the text message (and add variables) for each screen
- Add icons to the text message (TD 200C only)
- Determine the sequence of the screens for each group

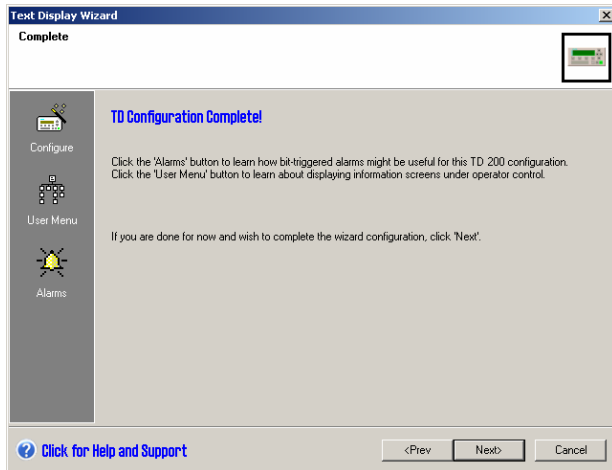

Figure 4-14 Selecting the Screen Configuration Tasks

Creating the User Menu

The process for creating the screens and user menu is not sequential: You can choose to enter the screens for each individual group before creating the next group, or you can enter all of the groups for the user menu before creating any of the screens.

To configure the user menu, you enter the names for each group of screens. See Figure 4-15 for an example of the TD 200C. The Text Display wizard displays a green ENTER icon (and blue arrow) to show which group is selected.

To create the screens associated with a group on the user menu:

1. Move the cursor to the box that designates the group on the user menu.
2. Click the Add Screen button.
3. Create the text for the screen.
4. Click the Add Screen button to create the other screens in this group.

Use the Move Choice Up and Move Choice Down buttons to change the sequence of the groups listed on the user menu.

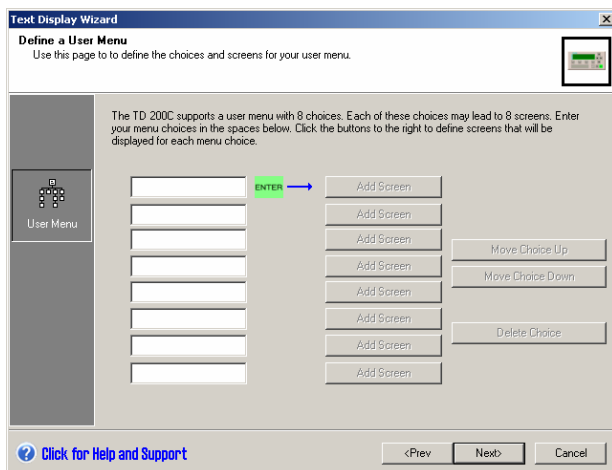

Figure 4-15 Defining the User Menu

Creating the Text for a Screen

Your screen message can contain the following elements:

- Text: Enter your text in the green area that represents the text display area of the TD device
- Icons (optional): Click the icons in the toolbar to insert the icon into the text message (TD 200C only)
- Variable data (optional): Click the Insert PLC Data button to embed a variable into the text message

You can designate the screen to be the default screen. The TD will show the default screen after being powered on.

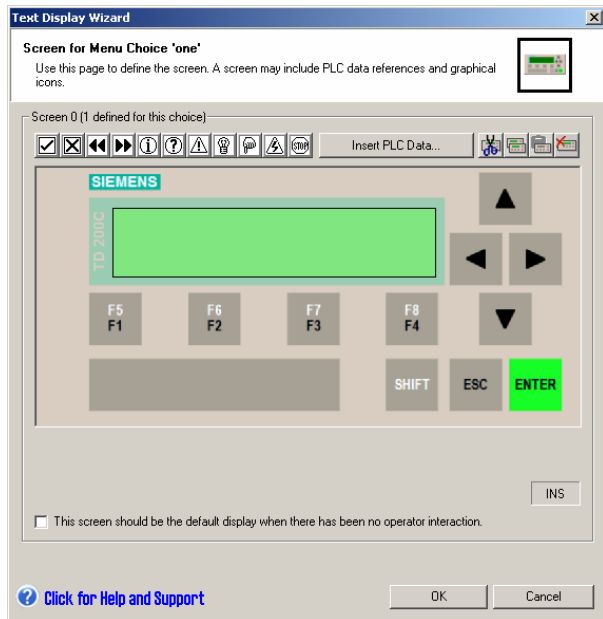

Figure 4-16 Creating the Message for a Screen

Embedding a Variable into the Text of a Screen

You can embed a variable data field into the text of the screen. To open the Insert PLC Data dialog, move the cursor to the location for the variable in your text and click the Insert PLC Data button. As shown in Figure 4-17, you enter the following information:



Tip

For the TD 200C and the TD 200, you can embed up to 6 variables per screen. For the TD 100C, you can embed up to 1 variable per line (4 variables per screen).

- Data address:
VB: Numeric String, Text String
VW: Signed, Unsigned
VD: Real, Signed, Unsigned
- Data Format: Signed, Unsigned, Real, Numeric String, or Text String
- Digits to the right of the decimal:
Up to 7

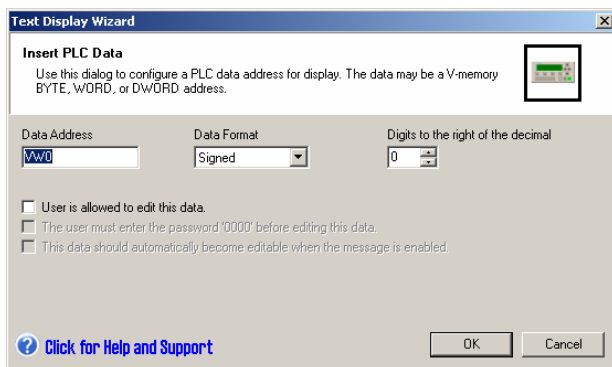

Figure 4-17 Inserting PLC Data

The TD device rounds a real number to the specified decimal place. For example, if the real number value is 123.456 and you select 2 digits to the right of the decimal, the TD 200 displays this value as: 123.46.



Tip

Refer to the *SIMATIC S7-200 Programmable Controller System Manual* for information about the data types or for the memory addresses supported by the S7-200 CPU.

You can also allow the operator to modify the data stored at this memory location in the S7-200 CPU.

- You can require the operator enter the TD password before editing the variable. (You must have enabled password-protection for the TD device.)
- You can configure the cursor to jump to the variable field.
- You can define a symbolic name for the variable. You use the symbolic name to access this data with your user program.

Clicking OK inserts the variable into the text of the screen. The Text Display wizard inserts a block of 4 characters to show the presence of the variable. The value to be displayed for the variable is right-justified at that location (anchored to the right-most character).

Data values are always right-justified to the right-most character of an embedded variable. As a data value grows in magnitude, it utilizes more spaces to the left of the anchor point and can overwrite the text characters. Always provide sufficient space between the end of your text and the anchor point to allow for the expected range of the data value.



Tip

The actual number of characters used to display a value varies with the size of the value. To help calculate the number of characters required for displaying the value of the variable, see the examples listed in Table 4-1.

The TD device displays all values as decimal numbers. Positive signed values are displayed without a sign, and negative signed values are displayed with a leading minus sign. Unsigned values are displayed without a sign. A leading zero is used for all fractional numbers (for example, 0.5). Real numbers are displayed with the number of decimal places you specify. The value is rounded to the specified decimal place.

Table 4-1 Calculating the Number of Characters Required to Display a Value

Size	Type	Resolution (Digits to right of decimal)	Maximum Number of Characters	Example
Byte (VB)	String	Not applicable	Line length ¹	Hello, world
	Numeric String	Not applicable	Line length ¹	800.333.7421
Word (VW)	Unsigned	0	5	12345
		1 to 4	6	1234.5, 1.2345
		5	7	0.12345
		6	8	0.012345
		7	9	0.0012345
	Signed	0	6	-12345
		1 to 4	7	-1234.5, -1.2345
		5	8	-0.12345
		6	9	-0.012345
		7	10	-0.0012345
Double-Word (VD)	Unsigned	0	10	1234567890
		1 to 7	11	123456789.1, 123.4567891
	Signed	0	11	-1234567890
		1 to 7	12	-123456789.1, -123.4567891
	Real	0	Line length ¹	-1234567
		1 to 7	Line length ¹	12345.6, 0.0123456

¹ The length of a line (number of characters in a line) varies by TD model and character size. The line length is always 20 for a TD 200 or TD 200C. The line length is either 12 or 16 characters for a TD 100C.

Embedded String Variables

There are special considerations when you set up a string variable for the TD devices. String variables are positioned the same as numeric variables, that is, the right-most character of the variable is positioned at the right-most position of the embedded variable in the Text Display wizard. This can cause problems when you want to place a text string adjacent to other text in the message.

When you embed a string variable in a TD alarm or screen, the Text Display wizard shows the embedded variable occupying 4 character spaces (or 2 Chinese characters) for the variable. These 4 spaces are the right-most 4 characters of the text string. If you want to have the text adjacent to other text, that is, to the left of the variable, the characters in the string need to be left-justified and padded with spaces to place the text in the proper position on the display.

For example: Assume that we want to show the pump status and that status is either “Pump OK” or “Pump High Temp”. The screen display shows the word “Pump” followed by a string variable which is set to either “OK” or “High Temp”. You set up the display in the Text Display wizard like this:

Pump_ _ _ _ _ □□□□

The underlines are blank spaces and the □□□□ is the embedded variable (which takes up 4 character spaces). You can create 2 strings that you copy into the variable based on the current pump status. These strings are “OK” and “High Temp”. These strings are displayed as shown in Figure 4-18.

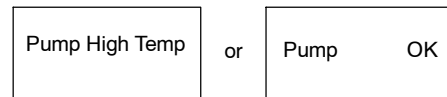

Figure 4-18 Embedded String Variable

The right-most character of the “OK” string is placed in the right-most position of the embedded variable. Since the string is only 2 characters, it displays on the right side of the display where the embedded variable is placed.

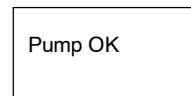

Figure 4-19 Embedded String Variable with Blank Spaces

To make the “OK” string display next to “Pump”, simply add blank spaces to the “OK” string to match the length of the other string. The “OK” string would become “OK ”. Now the string is displayed as shown in Figure 4-19.

Figure 4-20 shows how to create the two strings using the STR_CPY command. Note how the “OK” string is padded with blank spaces to left justify the characters on the TD display.

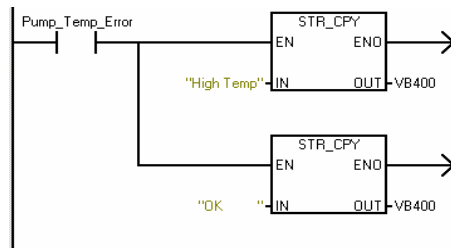

Figure 4-20 Using STR_CPY to Create Strings

Configuring the Alarms

Alarms allow the user program in the S7-200 CPU to initiate interaction with the operator by displaying an alarm message on the TD device. When your user program sets an alarm bit, the TD device reads the text of the alarm from the S7-200 CPU.

Figure 4-21 lists the key tasks for creating alarms. You configure the following information for each alarm:

- Number of alarms: Up to 80 alarms for the TD 200 and TD 200C, and up to 40 alarms for the TD 100C to be configured for the TD device
- Text message for the individual alarms
- Priority for the alarms is determined by the sequence in which you configure the alarms:
 - The first alarm has the highest priority
 - The last alarm has the lowest priority
- Acknowledgement (if required)

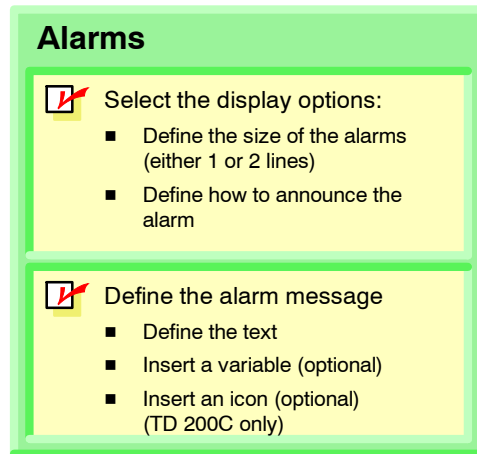

The TD 200 and TD 200C devices store up to 80 alarms, and the TD 100C device stores up to 40 alarms. The TD displays the alarm messages according to priority.

Figure 4-21 Configuring the Alarms

As shown in Figure 4-22, the operator uses the buttons on the keypad to scroll through the list of alarms.

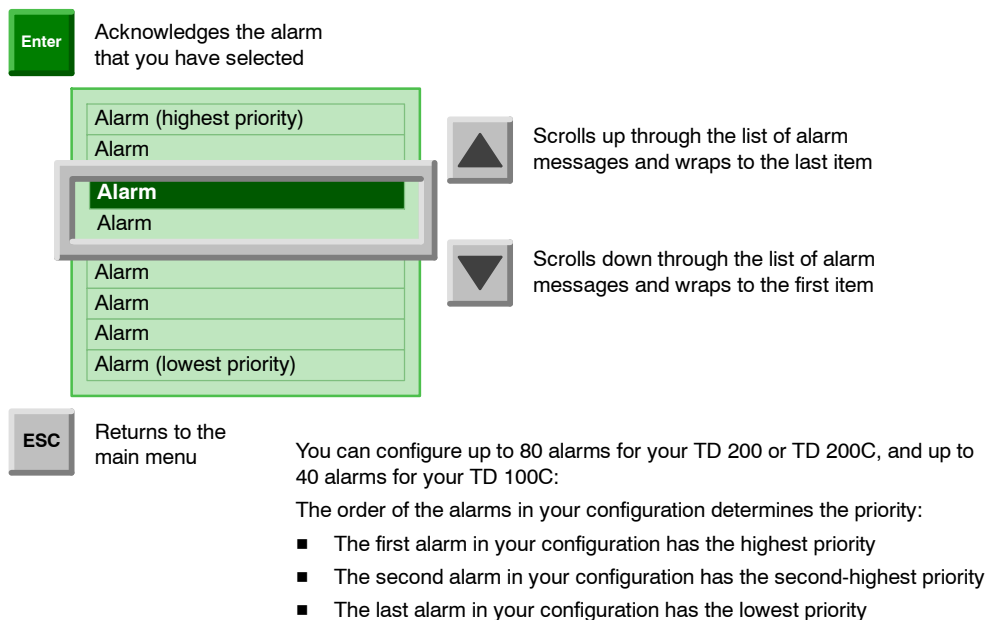

Figure 4-22 Alarm Messages

Determining the Type of Operator Interaction for an Alarm

The Text Display wizard allows you to determine the type of interaction required by the operator for an alarm. If the user screens are set as the default display mode for the TD device and an alarm is enabled, an alarm indicator will begin to flash on the TD display. The indicator is large if there is an alarm enabled that requires acknowledgement. The indicator will be small if the alarms do not require acknowledgement. The user can switch to the alarm display to view the alarms.

The alarm display will show one or more alarms in priority order. An UP or DOWN arrow in the right-most character position indicates more alarms are active, but not visible on the display. The operator can press either the UP or the DOWN arrow key to scroll through the other enabled alarms.

The operator can edit or accept variable values by pressing the ENTER key. The TD device will write the updated variable value to the CPU and set the edit notification bit for that variable when the operator presses the ENTER key. The TD device then moves the cursor to the next editable variable. Pressing ENTER for the last editable variable of an alarm writes this last value to the S7-200 CPU and the TD device then resets the alarm enable bit. For more information on editing variables, see *Editing a Variable that is Embedded in an Alarm or a Screen* in Chapter 5.

Every alarm falls into one of four possible alarm acknowledgement and editing types. This section explains specifically how each alarm type is handled by the TD device. The four alarm types follow:

- No acknowledgement required, no edits allowed
- Acknowledgement required, no edits allowed
- No acknowledgement required, edits allowed
- Acknowledgement required, edits allowed

No Acknowledgement Required, No Edits Allowed

In this combination of no acknowledgement required and no edits allowed, the TD device simply displays the alarm. The ENTER key has no function since there are no editable variables within the alarm. The alarm may contain variables that are updated at the update rate of the TD device. This type of alarm is replaced on the display if a higher priority alarm is enabled by the S7-200 CPU. The operator can either press the UP or the DOWN arrow key to scroll to other alarms or press ESC to return to the menus.

The TD device does not clear the corresponding alarm-enable bit in the S7-200 CPU.

Acknowledgement Required, No Edits Allowed

In this combination of acknowledgement required and no edits allowed, the TD device displays the alarm and makes the entire alarm flash (blink) until the operator presses ENTER to acknowledge the alarm. Variable values are updated from the S7-200 CPU at the normal update rate while the alarm is flashing.

When the operator presses ENTER, the TD device:

- Sets the acknowledgement-notification bit for this alarm.
- Clears the alarm-enable bit for this alarm. This causes the alarm to be removed from the display on the next update cycle.

Another alarm cannot replace the one flashing until the operator acknowledges the flashing alarm. This is also true even if a higher priority alarm is enabled in the S7-200 CPU. If the TD device is configured for single line alarms and the CPU enables a higher priority alarm, the flashing alarm shifts down to the next line of the display. The operator cannot press the UP or the DOWN key to scroll through other enabled alarms until the current alarm is acknowledged.

No Acknowledgement Required, Edits Allowed

In this combination of no acknowledgement required and edits allowed, the TD device displays a alarm and then waits for the operator to edit a value in the alarm. All of the variables within the alarm are updated at the update rate. Since the alarm does not require acknowledgement, this type of alarm is removed from the TD device display if a higher priority alarm is enabled in the S7-200 CPU.

Acknowledgement Required, Edits Allowed

In this combination of acknowledgement required and edits allowed, the TD device displays the alarm, causes the entire alarm to flash (blink), and then waits until the operator acknowledges the alarm and edits or accepts the values in the alarm. This type of alarm requires that the operator edits or accepts the values displayed in the alarm. If the operator aborts the edit by pressing the ESC key before editing all the values in the alarm, the alarm flashes to indicate that edits are still required.

When the alarm is enabled in the S7-200 CPU, the TD device notes this and, if there is space available on the display, reads the alarm from the CPU. The TD device then displays the alarm and causes the entire alarm to flash to notify the operator that the alarm is present and must be acknowledged.

Setting the Default Display Mode and Alarm Parameters

The TD device supports alarms that are displayed under program control. After you have configured the TD device, you can configure the alarms. When you configure the alarms, you also select either screens (default) or alarms as the default display mode for the TD device.

Click the Alarms icon to start creating alarms. As shown in Figure 4-23, you select the following information:

- Default display mode: Select either alarms or screens as the default display mode. This selects which type of messages the TD device displays after powering up or after a prolonged period of no key presses by the user.
- Size of the alarms: Select either 1 line or 2 lines.

For Chinese characters, select either one row or two rows of text.

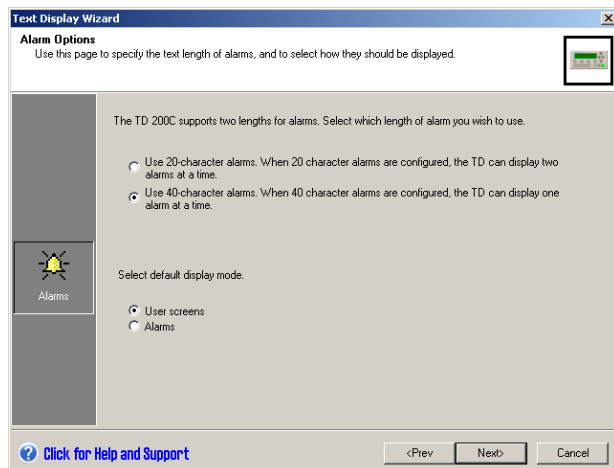

Figure 4-23 Configuring the Alarm Options



Tip

The TD 200C and the TD 200 support up to 80 alarms, and the TD 100C supports up to 40 alarms. The priority for the alarms is determined sequentially, from the first alarm (highest priority) to the last (lowest priority).

Entering the Text for an Alarm

Clicking Next displays the Alarms dialog shown in Figure 4-24. You can select a symbolic name for the alarm. The user program uses the symbolic name to enable (and display) the alarm. Click the New Alarm button to create the alarm message. Your alarm message can contain the following elements:

- Text: Enter your text in the green area that represents the text display area of the TD device
- Icons (optional, TD 200C only): Click the icons in the toolbar to insert the icon into the text message
- Variable data (optional): Click the Insert PLC Data button to embed a variable into the text message

To ensure that important alarms are acknowledged by an operator, you can configure the alarm to require acknowledgement.

You select the symbolic name for the acknowledgement bit for the alarm. The user program uses this symbolic name to report that the alarm has been acknowledged.

To acknowledge an alarm with the TD device, the operator selects the alarm and presses ENTER.

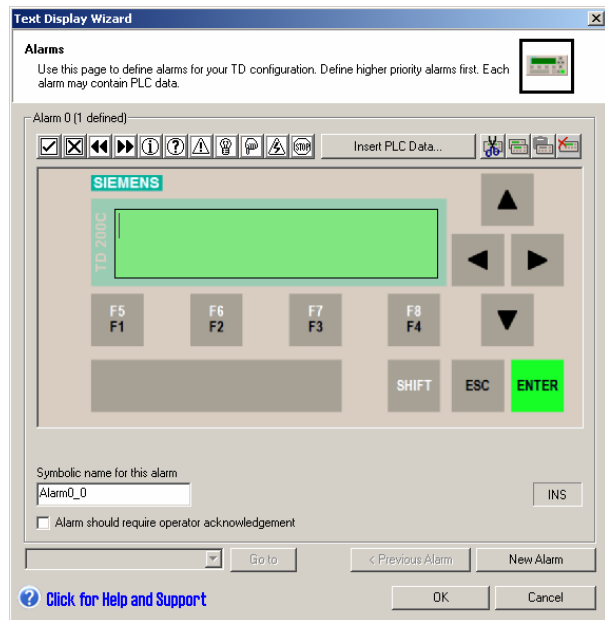

Figure 4-24 Creating the Text for an Alarm

Embedding a Variable into the Text of an Alarm

You can embed a variable data field into the text of the alarm. To embed a variable, move the cursor to the location for the variable in your text and click the Insert PLC Data button. As shown in Figure 4-25, you enter the following information:



Tip

For the TD 200C and the TD 200, you can embed up to 6 variables per alarm. For the TD 100C, you can embed up to 1 variable per line (1 for one-line alarms, and 2 for two-line alarms).

- Data address:
 - VB: Numeric String, Text String
 - VW: Signed, Unsigned
 - VD: Real, Signed, Unsigned
- Data Format: Signed, Unsigned, Real, Numeric String, or Text String
- Digits to the right of the decimal: Up to 7

The TD device rounds a real number to the specified decimal place. For example, if the real number value is 123.456 and you select 2 digits to the right of the decimal, the TD 200 displays this value as: 123.46.

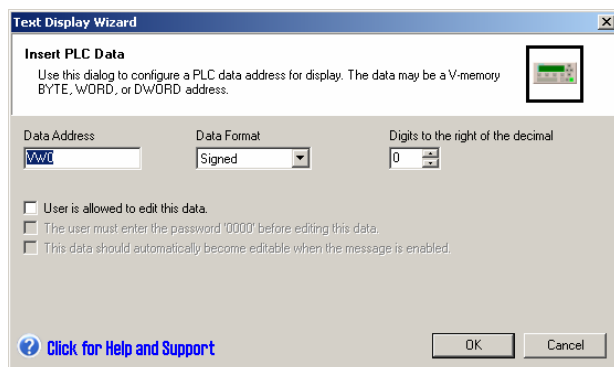

Figure 4-25 Inserting a Variable into the Text of an Alarm

**Tip**

Refer to the *SIMATIC S7-200 Programmable Controller System Manual* for information about data types or for the memory addresses supported by the S7-200 CPU.

You can also allow the operator to modify the data stored at this memory location in the S7-200 CPU.

- You can require the operator enter the TD password before editing the variable. (You must have enabled password-protection for the TD device.)
- You can configure the cursor to jump to the variable field.
- You can define a symbolic name for the variable. You use the symbolic name to access this data with your user program.

Clicking OK inserts the variable into the text of the alarm. The Text Display wizard inserts a block of 4 characters to show the presence of the variable. The value to be displayed for the variable is right-justified at that location (anchored to the right-most character).

Data values are always right-justified to the right-most character of an embedded variable. As a data value grows in magnitude, it utilizes more spaces to the left of the anchor point and can overwrite the text characters. Always provide sufficient space between the end of your text and the anchor point to allow for the expected range of the data value.

**Tip**

The actual number of characters used to display a value varies with the size of the value. To help calculate the number of characters required for displaying the value of the variable, see the examples listed in Table 4-2.

The TD device displays all values as decimal numbers. Positive signed values are displayed without a sign, and negative signed values are displayed with a leading minus sign. Unsigned values are displayed without a sign. A leading zero is used for all fractional numbers (for example, 0.5). Real numbers are displayed with the number of decimal places you specify. The value is rounded to the specified decimal place.

For more information about embedding string variables in an alarm, see page 53.

Table 4-2 Calculating the Number of Characters Required to Display a Value

Size	Type	Resolution (Digits to right of decimal)	Maximum Number of Characters	Example
Byte (VB)	String	Not applicable	Line length ¹	Hello, world
	Numeric String	Not applicable	Line length ¹	800.333.7421
Word (VW)	Unsigned	0	5	12345
		1 to 4	6	1234.5, 1.2345
		5	7	0.12345
		6	8	0.012345
		7	9	0.0012345
	Signed	0	6	-12345
		1 to 4	7	-1234.5, -1.2345
		5	8	-0.12345
		6	9	-0.012345
		7	10	-0.0012345
Double-Word (VD)	Unsigned	0	10	1234567890
		1 to 7	11	123456789.1, 123.4567891
	Signed	0	11	-1234567890
		1 to 7	12	-123456789.1, -123.4567891
	Real	0	Line length ¹	-1234567
		1 to 7	Line length ¹	12345.6, 0.0123456

¹ The length of a line (number of characters in a line) varies by TD model and character size. The line length is always 20 for a TD 200 or TD 200C. The line length is either 12 or 16 characters for a TD 100C.

Configuring the Language Sets for the TD Device (TD 200C, TD 200 only)

The Text Display wizard allows you to configure multiple language sets for your TD 200C and TD 200, including not only the system prompts or messages, but also for the user alarms, user menus, and screens. The Text Display wizard copies the user alarms and user screens that you have configured into the language set. You must manually enter the translated text for each alarm, menu, or screen.

For each language set, you select the following information:

- Language for the system prompts
- Character set
- Identifier

You also select which of the language sets is the primary language for the TD device.

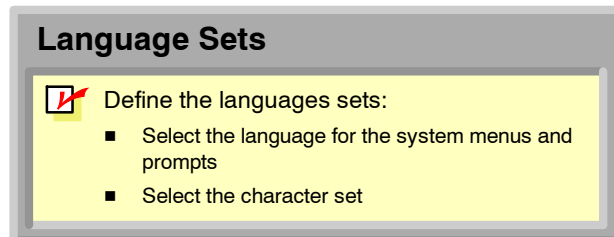

Figure 4-26 Configuring the Languages for the TD Device



Tip

When you create multiple language sets, the Text Display wizard copies the user alarms, menus, and screens from the primary language set to the other language set. You then edit the alarms, menus, and screens to translate the text displayed for the new language set.

If you need to modify the screens or messages (such as to add a new variable or to add a new alarm), you must edit the primary language. The Text Display wizard copies these changes to the other language sets.

The Text Display wizard only allows you to change the text in the other language sets.

After you have configured the alarms and screens for one language set, you can add a new language set:

1. Click the icon to start configuring the language sets for the TD device.
2. Add a new language by selecting **New Language Set**.
3. Select an existing language set to be the source for the new language set.
4. (Optional) Select the option for primary language to configure the new language as the default language set for the TD device.
5. Click the **Next** button to display the **Localize Display** dialog.

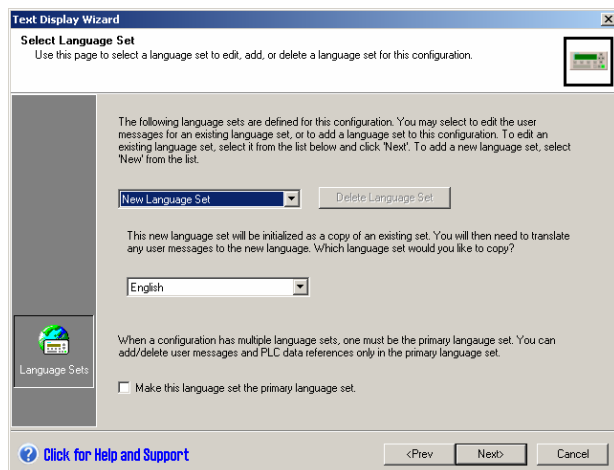

Figure 4-27 Adding a Language

The Localize dialog configures the menus and character set for the TD device:

1. Select the language for the system menus and prompts of the TD device.
2. Select the character set for the text.
3. Enter the name to be displayed on the TD device for this language set.

After you click the Next button, the Text Display wizard copies all of the user alarms, menus, and screens from the selected language set to the new language set.

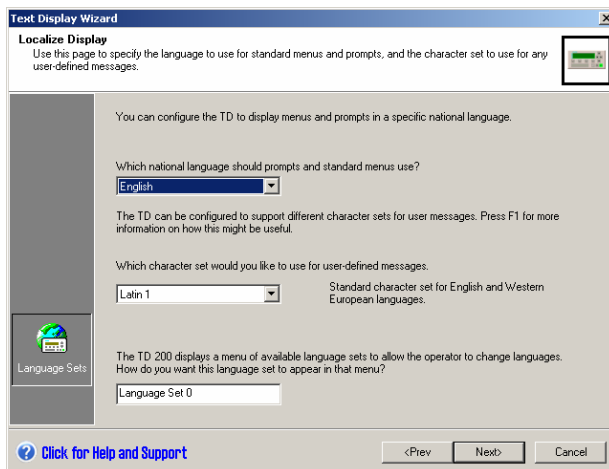

Figure 4-28 Localizing the Display

Notes for Using the Simplified Chinese Character Set



Tip

The Simplified Chinese character set requires a Chinese version of Windows or a Chinese emulator to properly display Chinese characters in the Text Display wizard. You must start the Chinese emulator before you start the STEP 7-Micro/WIN software.

On the TD 200C and the TD 200, you can display up to 20 single-byte characters per line of your message. Because Simplified Chinese uses double-byte characters, you can display up to 10 double-byte characters per line for a message in Chinese.

On the TD 100C, you can display up to 16 single-byte characters per line of your message. Because Simplified Chinese uses double-byte characters, you can display up to 8 double-byte characters per line for a message in Chinese.

The standard ASCII characters, such as numbers, punctuation, and upper and lowercase alphabet characters, are available when using the Simplified Chinese character set. Depending on your keyboard and/ or emulator, some of these standard characters may be formatted as single-byte characters instead of the double-byte characters like the Simplified Chinese characters. Standard ASCII characters and Chinese characters can be mixed on the TD display.

The Text Display wizard displays 8 or 10 double-byte character places for the text of a screen or alarm. You can fit any of the following combinations into a character position:

- 1 double-byte character
- 2 single-byte characters (standard ASCII)
- 1 single-byte character and 1 single-byte blank

You cannot fit one single-byte character plus one double-byte character in a character position.

The TD 100C does not support the entire Simplified Chinese character set. The most commonly used characters have been included in the TD 100C. Characters that are not supported by the TD 100C are displayed as a square (□).

See the *Simplified Chinese Characters Set* on the STEP 7-Micro/WIN documentation CD for a list of supported characters.

Assigning the V Memory Address for the Parameter Block

The Text Display wizard creates the parameter block that you download to the S7-200 CPU with your user program. The parameter block includes the configuration data for the TD device and any screens and alarms that you created.

The Text Display wizard calculates the amount of memory required for the parameter block and suggests a starting address in V memory.

The default location for the parameter block is VB0.



Figure 4-29 Assigning the Address of the Parameter Block

Finishing the Configuration for the TD Device

After you complete the configuration for your TD device, the Text Display wizard displays a summary dialog. (See Figure 4-30.)

If you enter a name for the TD configuration, STEP 7-Micro/WIN creates an entry in the project tree for the TD configuration.

STEP 7-Micro/WIN also creates the following subroutines:

- TD_CTRL_x (where x is the TD configuration number)

This subroutine ensures that all updates for the TD device (such as alarms or changing the language setting) occur immediately.

Your user program should use SM0.0 to call this subroutine every scan.

- TD_ALM_x (where x is the TD configuration number)

Your user program uses this subroutine to call the alarm by the symbolic name (configured by the Text Display wizard). This subroutine requires the S7-200 Symbol Table.

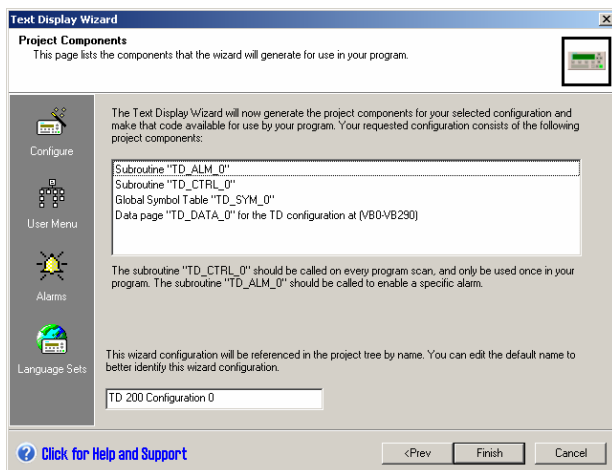

Figure 4-30 Summary Dialog

Operating Your TD Device

5

Included in this chapter is information about routine operator tasks, such as entering and releasing the password, editing variables embedded in a message or screen, and checking the status information of the S7-200 CPU. This chapter also describes the less-routine diagnostic functions provided by the TD device for troubleshooting problems in the S7-200 CPU, such as forcing I/O or changing the operating mode.

In This Chapter

Using the TD Device to Access Screens and Alarms	64
Displaying Information on the TD Device	66
Using the TD Device to Edit Variables in the S7-200 CPU	67
Accessing the Menus and Screens	68
Entering and Releasing a Password	70
Entering the Password	70
Releasing the Password	70
Viewing the Screens and the Alarms	71
Displaying the Alarms	72
Clearing an Alarm	75
Editing a Variable that is Embedded in an Alarm or a Screen	75
TD Bit Usage	76
Performing Typical or Routine Operator Tasks	78
Viewing the Status of an S7-200 CPU	78
Setting Time and Date in the S7-200 CPU	80
Changing the Language Set (TD 200C and TD 200 only)	81
Cleaning the Keypad	81
Performing Specialized Operator Tasks (Diagnostic/Setup Menu)	82
Setting up the TD Device	83
Viewing the TD Messages Stored in the S7-200 CPU (TD 200C, TD 200 only)	84
Forcing the Inputs and Outputs in the S7-200 CPU (TD 200C, TD 200 only)	84
Changing the Operating Mode of the S7-200 CPU (TD 200C Only)	85
Copying the User Program to a Memory Cartridge (TD 200C Only)	85
Editing the CPU Memory (TD 200C Only)	86

Using the TD Device to Access Screens and Alarms

The TD devices allow you to structure information as either screens or bit-enabled alarm messages. You use the buttons of the keypad of the TD device to navigate through the screens and menus:

- ❑ TD 200: Uses the standard TD keypad.
- ❑ TD 100C and TD 200C: Allows you to change the configuration and use your own custom-designed keypad. (If there is no custom configuration, the TD 100C and TD 200C defaults to the standard TD keypad configuration.)



Tip

For more information about configuring the functionality of the buttons on the keypad:

- Chapter 4 provides information about configuring the buttons for the TD devices. The TD configuration is downloaded to the S7-200 CPU with your user program.
- Chapter 3 provides information about creating a custom keypad layout for the TD 100C and the TD 200C, and assigning specific functionality for each button. (You then integrate the custom keypad with the screens and alarm messages as described in Chapter 4.)

As shown in Figure 5-1 and Figure 5-2, the standard TD keypad provides the following buttons:

- ❑ ENTER and Escape (ESC) buttons:
 - ENTER selects a menu item or confirms a value.
 - ESC exits from a menu or cancels a selection.
- ❑ Configurable buttons:
 - Function keys perform the task that you configured with the Text Display wizard. The TD 200 and TD 200C uses F1 to F4, and the TD 100C uses F1 and F2.
 - SHIFT on the TD 200 and TD 200C allows the function keys (F5 to F8) to perform the task that you configured with the Text Display wizard.

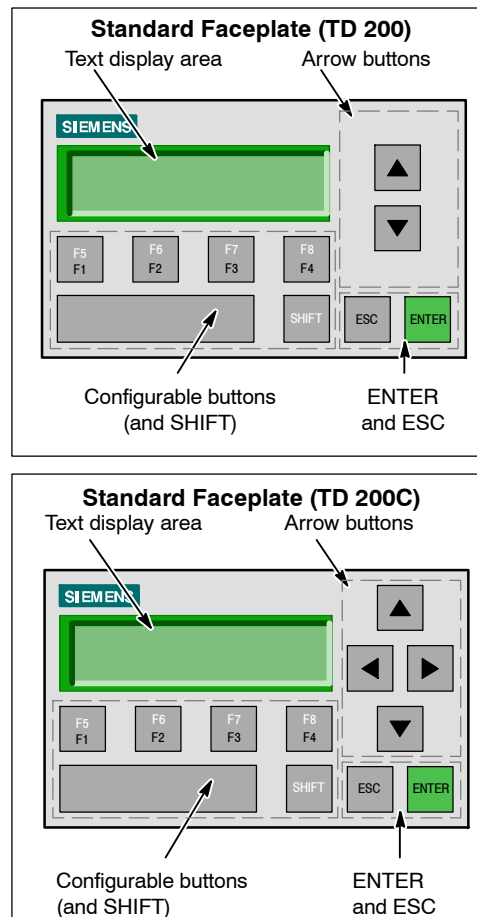
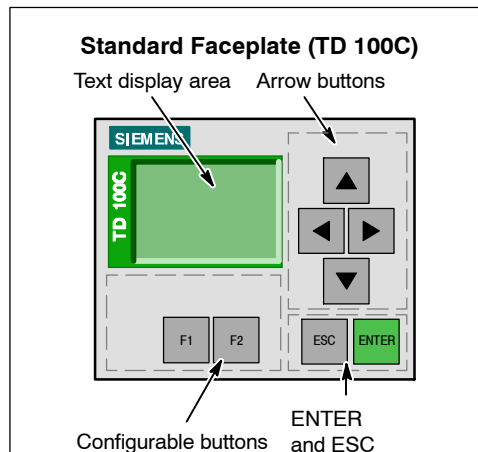

Figure 5-1 Standard TD 200 and TD 200C Keyboard

- ❑ Arrow buttons:
 - UP arrow scrolls (upwards) through menu items or increments a value that can be edited.
 - DOWN arrow scrolls (downwards) through menu items or decrements a value that can be edited.
 - LEFT and RIGHT arrows move the cursor left or right within the message (TD 100C and TD 200C only). For a TD 200, use SHIFT+DOWN to move right and SHIFT+UP to move left. You can also use ENTER to move to the next variable message.



To select a menu item, use the UP and DOWN arrows to scroll through the list of available items. The TD device highlights the menu item.

Figure 5-2 Standard TD 100C Keyboard

- ❑ Pressing ENTER selects the highlighted item.
- ❑ Pressing ESC returns to the previous menu or screen.

Displaying Information on the TD Device

The TD device provides both screens (user-defined menus with associated screens of information) and bit-enabled alarm messages:

- ❑ Menu: A menu is a list of items that select a grouping of related screens. The TD 200C and the TD 200 have 8 menus available; the TD 100C has 4 menus available.
- ❑ Screen or alarm:
 - A screen or alarm for the TD 200 and TD 200C displays up to two lines of text that provide information for the operator. (Each line can be up to 20 characters of text and data. A screen contains up to 40 characters of text and data. An alarm can be either 1 or 2 lines.)
 - A screen or alarm for the TD 100C displays up to four lines of text that provide information for the operator. (Each line can contain either 12 or 16 characters of text and data. A screen contains 48 or 64 characters of text and data. An alarm can be either 1 or 2 lines.)

The textual message of the screen or alarm can convey information for the operator and can also allow the operator to interact with the S7-200 CPU by changing the embedded value of a variable (such as a set point or limit).

You can configure the TD device to display screens (which are initiated by operator action) and bit-enabled alarms (which are generated by the S7-200 CPU). You can also configure the TD 200C and the TD 200 device to display an icon to alert the operator of some event or action required. (Refer to Chapter 4 for information about configuring the TD device.)



Tip

Pressing ESC returns you to the previous menu. If there is no activity for 20 seconds (no button pressed), the TD device returns to the default display mode.

The operator uses the buttons on the keypad to navigate through the menu or a list of text. Figure 5-3 shows the buttons that an operator could use to navigate from a user menu to the screens associated with that item in the menu. Figure 5-4 shows how to navigate through the alarms. The TD 200C and the TD 200 have eight menus available, and the TD 100C has four menus available.

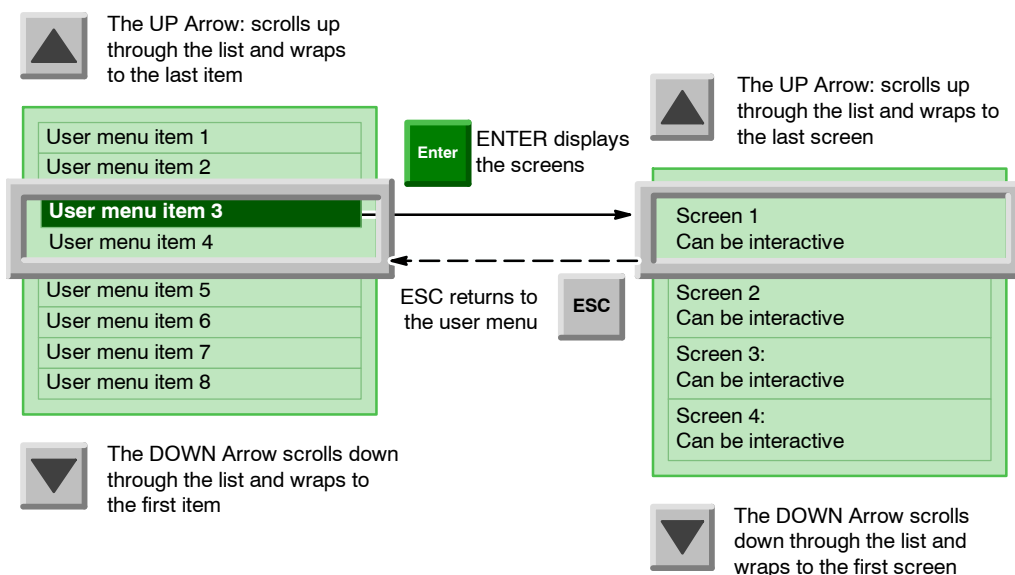

Figure 5-3 Using the Keypad to Navigate between User Menus and Screens

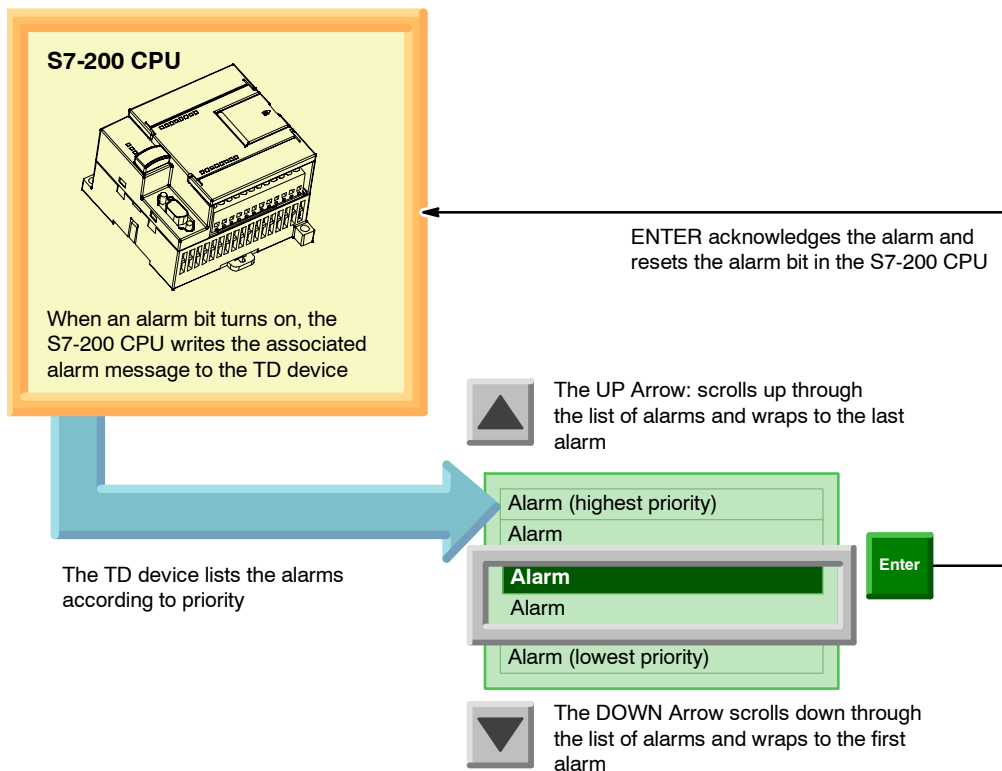

Figure 5-4 Displaying and Acknowledging Alarms

Using the TD Device to Edit Variables in the S7-200 CPU

A screen or alarm message can contain an embedded variable field that allows an operator to respond by changing the value of the variable. The operator uses the keypad to edit variables:

- Selecting the Screen:** The operator uses the UP or DOWN arrows to display the screen that contains the variable to be edited. (From a menu, the operator presses ENTER to access the group of screens.)
- Navigating to the variable:** The operator presses ENTER to navigate to the first editable variable.
- Changing the value of the variable:** Pressing the UP arrow increments (increases) the value, and pressing the DOWN arrow decrements (decreases) the value. (Pressing and holding the UP or DOWN arrow accelerates the operation.) Pressing both SHIFT+ENTER resets the variable to 0. Pressing ESC aborts the edit.
- Press LEFT or RIGHT to move the cursor position within the variable.** The TD 200 uses SHIFT+UP to move left and SHIFT+DOWN to move right.
- Updating the data in the S7-200 CPU:** Pressing ENTER writes the updated value for the variable to the S7-200 CPU and moves the cursor to the next editable variable on the screen.

For more information about editing variables, see the section *Editing a Variable that is Embedded in an Alarm or a Screen* in this chapter.

Accessing the Menus and Screens

When you configured the TD device (as described in Chapter 4), you created the screens and alarms for the TD device. If you configured both alarms and screens, you also designated which type of message (screens or the alarms) would be the default display mode for the TD device. After power-up or after a period of inactivity, the TD device returns to the default display mode.

In addition to the screens and alarms that you configured, the TD device provides standard functions that the operator can access from system-level and pre-defined menus. From the default display mode, the operator uses ESC to access the menu hierarchy. The operator then presses ENTER to select the menu item for accessing the other menus or functions. Figure 5-5 and Figure 5-6 show the hierarchy of menus for these functions for the TD devices. (The menus show all of the functions that are available on the TD device. For some of the functions to be listed on the menu, you must have enabled the function during configuration. See Chapter 4.)

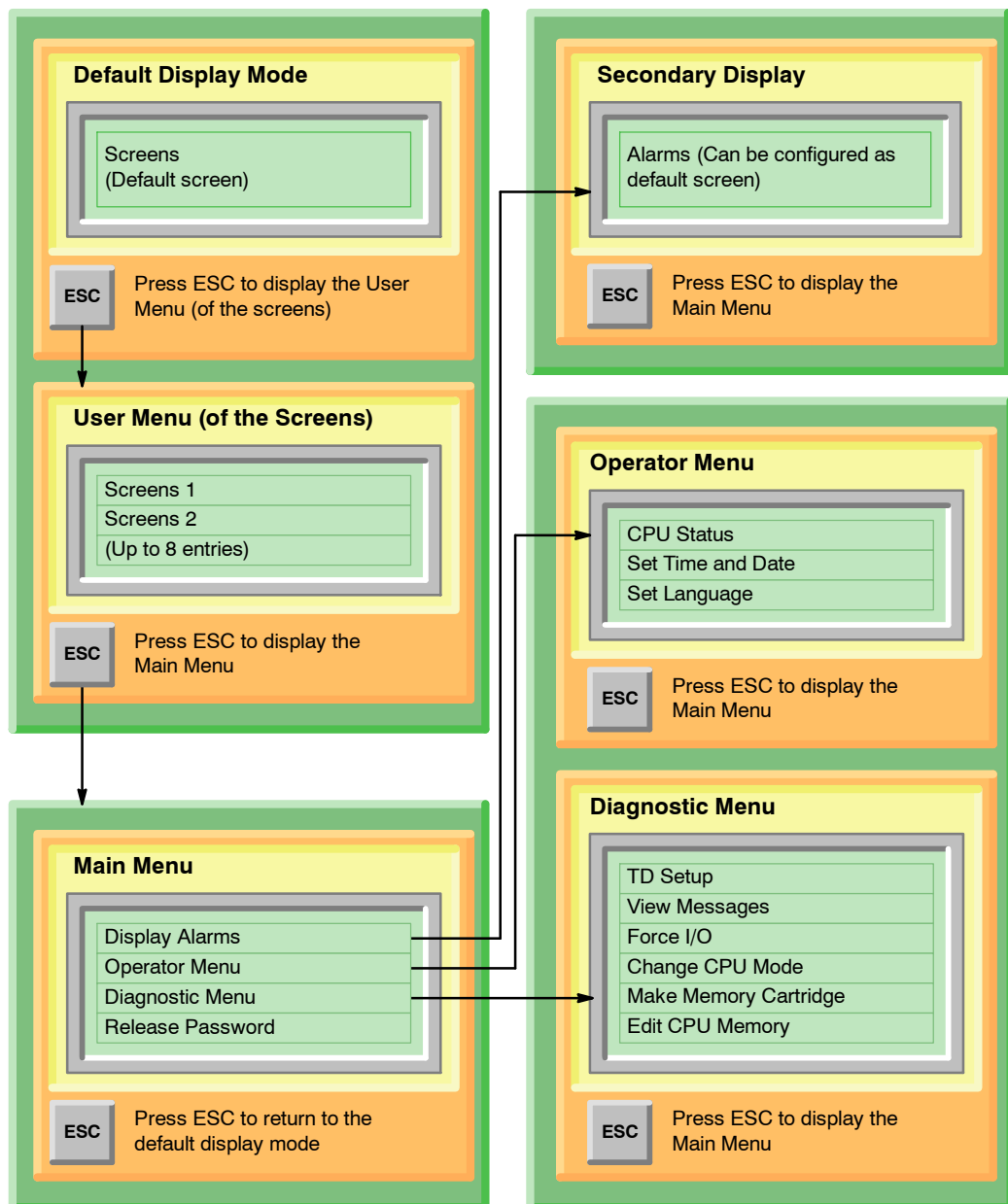

Figure 5-5 Menu Hierarchy for the TD 200 and TD 200C

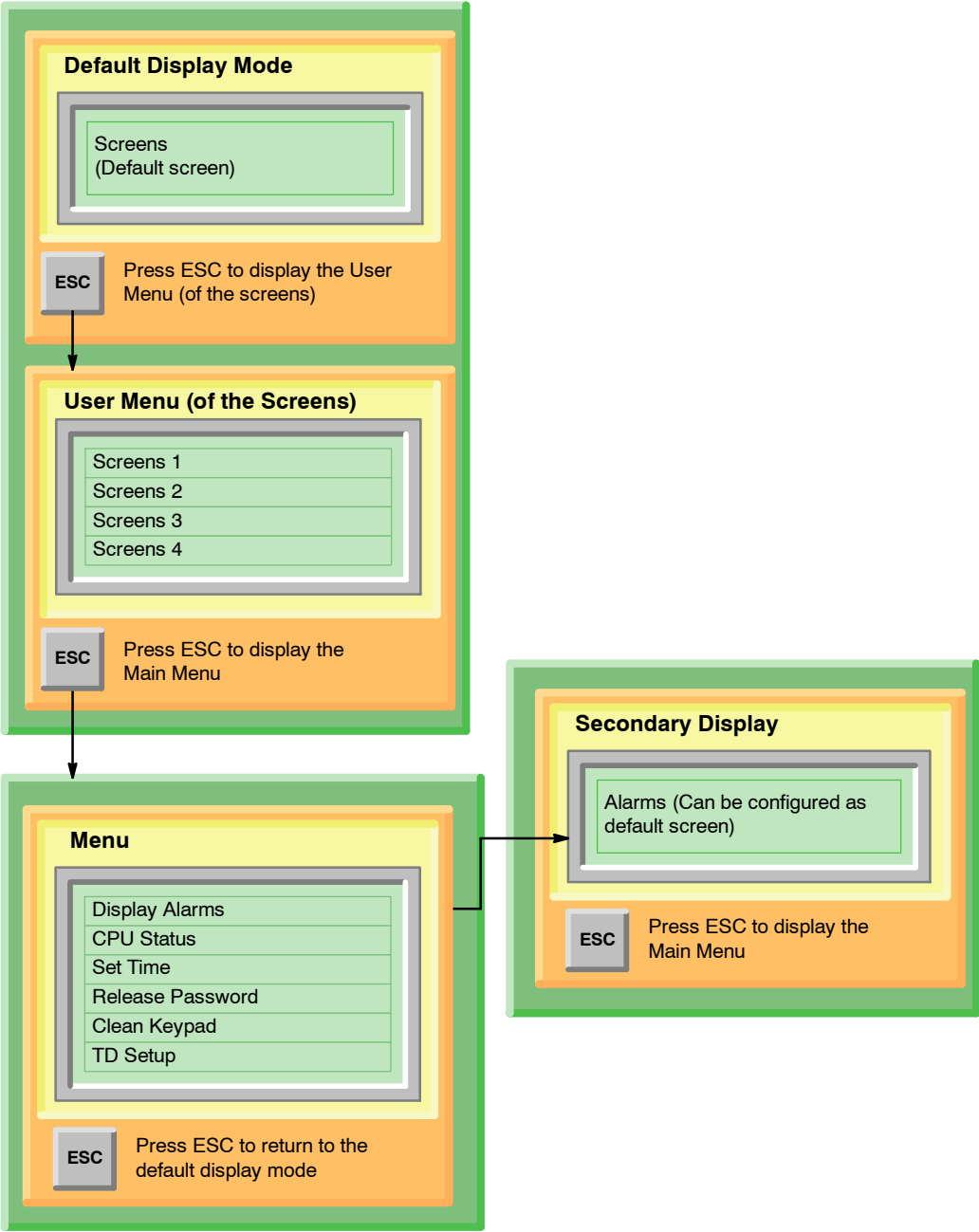

Figure 5-6 Menu Hierarchy for the TD 100C

Entering and Releasing a Password

You use the Text Display wizard of STEP 7-Micro/WIN to configure the password for the TD device. Refer to Chapter 4 for information about configuring the TD device. To ensure that an unauthorized user does not have access to the TD device during an interval for the automatic time-out, you can use the Release Password feature.

Certain operations (such as forcing I/O or making a memory cartridge) may also require that the operator enter the 8-character CPU password for the S7-200 CPU. (You must have enabled the S7-200 CPU for password-protection in order for the TD device to prompt the operator for the CPU password.)

Entering the Password

If configured for a password, the TD device prompts the operator to enter the 4-digit password before allowing the operator to access screens or menus. If the password uses fewer than 4 digits, the operator must press ENTER for the unused (remaining) characters.

Use the UP or DOWN arrow to select each digit of the password, pressing ENTER to move to the next digit. You can also use the RIGHT and LEFT arrows to move within the password.

The TD device provides a time-out feature which automatically restores password protection after a period of inactivity. If no buttons have been pressed after 2 minutes, the TD device then requires a password again before allowing an operator to access menus or to edit variables.

Releasing the Password

In order to provide additional security for your application, the TD device provides a Release Password command that immediately restores the password-protection. The TD device then requires that the operator enter the password before allowing access. The Release Password command prohibits another person from using the TD device without first entering a password (for example, before a password entered by an operator times out).

You access the Release Password command from the main menu, as shown in Figure 5-7.

The Release Password is not applicable for the CPU password: The TD device releases the CPU password as soon as the operator exits the function that required the password.

For example: If the operator entered the CPU password in order to force an I/O point in the S7-200 CPU, the TD device releases the CPU password as soon as the operator exits the Force menu.

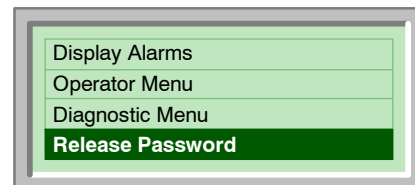

Figure 5-7 Release Password Command

The Release Password command is available only if you defined a 4-digit password when you configured the TD device.

Viewing the Screens and the Alarms

As described in Chapter 4, you can configure screens and alarms for the TD device. If you configure both alarms and screens, you also designate which set of messages (screens or alarms) are the default display mode for the TD device. The default configuration selects the screens to be the default display.

After power-up or after a period of inactivity (one minute), the TD device returns to the default display mode. As shown in Figure 5-8 and Figure 5-9, the operator can switch between the default display mode and the secondary display mode.



Tip
For the TD 100C and the TD 200C: If you do not configure buttons for ESC or ENTER, you cannot access the main menu.

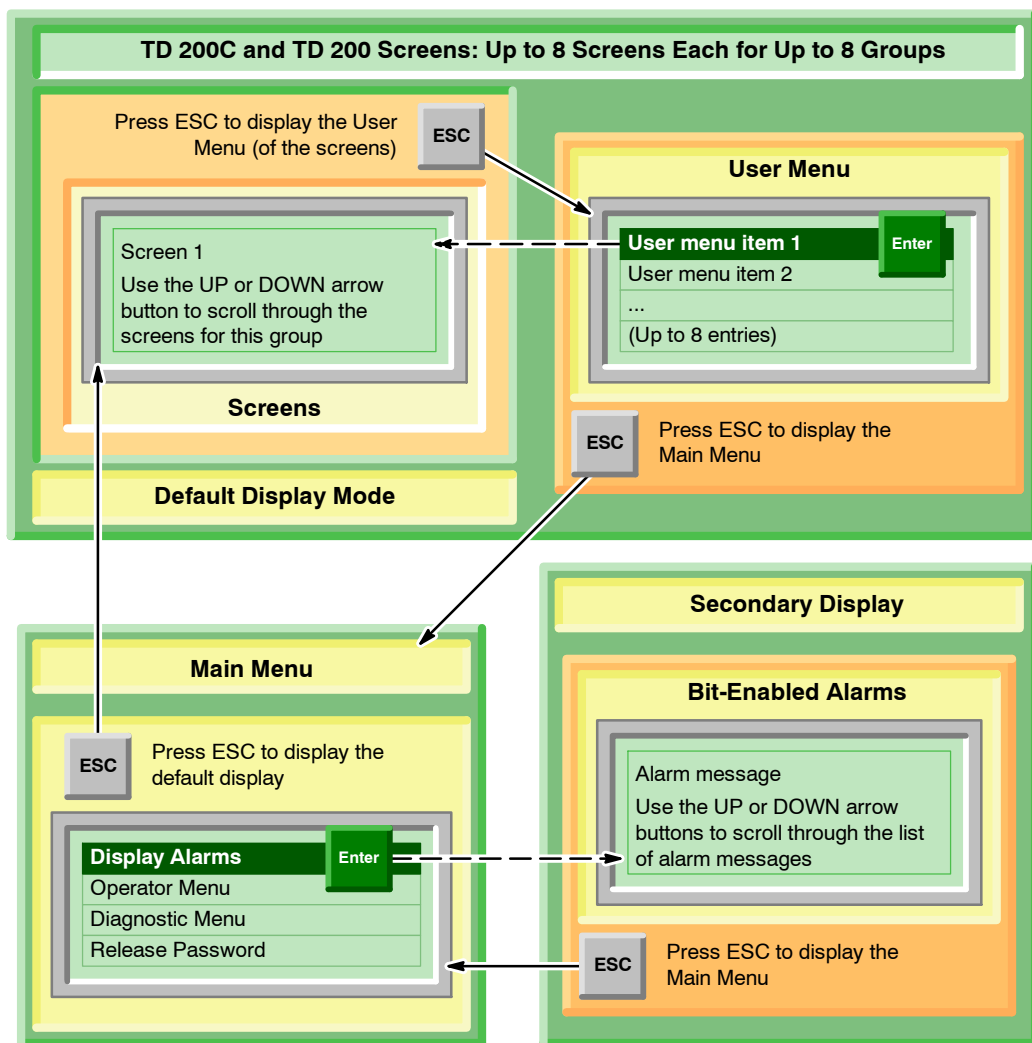

Figure 5-8 TD 200C and TD 200 – Navigating between the Default and Secondary Displays

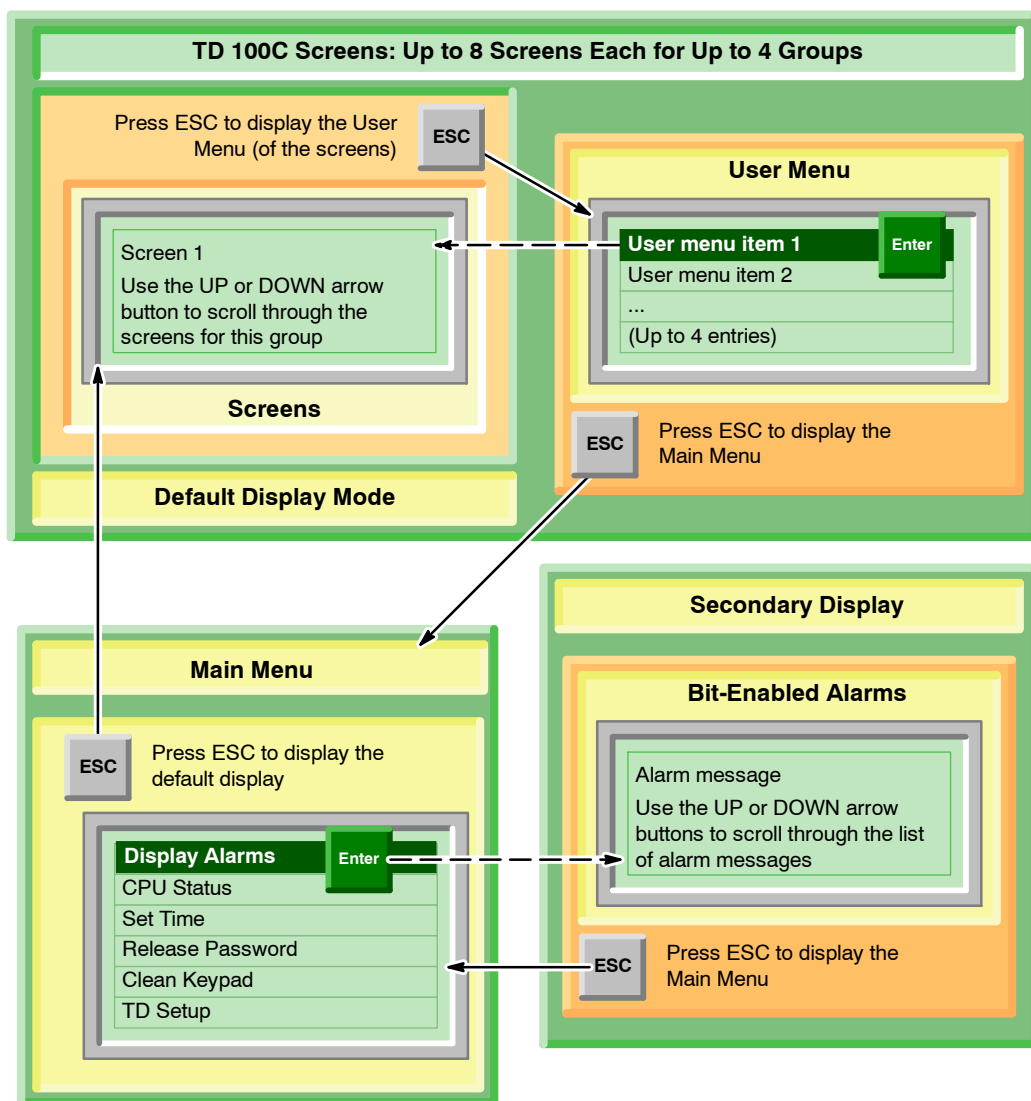

Figure 5-9 TD 100C - Navigating between the Default and Secondary Displays

Displaying the Alarms

If you created both screens and alarms when you configured the TD device, the main menu of the TD device includes a command that allows you to access the secondary (non-default) display. The TD device always returns to the default display mode after a period of inactivity.

As shown in the TD 200C example in Figure 5-10, the main menu provides a Display Alarms command for the default TD configuration. If you configured alarms as the default display, the main menu lists a User Menu entry.

After displaying the alarms, you use the UP and DOWN arrows to scroll through the sequential list of alarms.

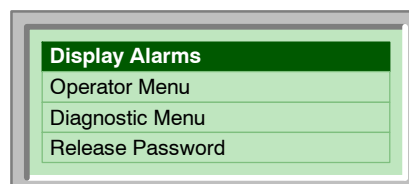

Figure 5-10 Displaying the Alarms



Tip

The TD 100C and the TD 200C allow you to configure a button specifically for displaying alarms when you are creating your custom keypad.

The TD device displays the highest priority alarm. The TD device displays an up or down arrow with the alarm to alert the operator that other alarms have been enabled. (The up arrow shows that higher-priority alarms have been enabled, and the down arrow shows that lower-priority alarms have been enabled.)

After reading a new alarm from the S7-200 CPU, the TD device sorts the alarms again to display the highest priority alarms at the top of the list. The TD device determines the priority based on the sequence of the alarms in the parameter block:

- The first alarm that you created has the highest priority.
- The second alarm that you created has the second-highest priority.
- The last alarm that you created has the lowest priority.



Tip

You can scroll up and down through the list of enabled alarms. However, the TD device returns to the highest-priority alarm after a period of inactivity: If you have not pressed a button for 10 seconds while the TD device has displayed the current alarm, then the TD device automatically returns to the highest-priority alarm.

Acknowledging an Alarm

If an alarm requires acknowledgement, the TD device does not remove that alarm until you acknowledge the alarm:

1. Use the UP or DOWN arrow to select the alarm.
2. Press ENTER to acknowledge the alarm.

Types of Alarms

The Text Display wizard allows you to determine the type interaction required by the operator for an alarm. If the user screens are set as the default display mode for the TD device and an alarm is enabled, an alarm indicator will begin to flash on the TD display. The indicator is large if there is an alarm enabled that requires acknowledgement. The indicator will be small if the alarms do not require acknowledgement. The user can switch to the alarm display to view the alarms.

The alarm display will show one or more alarms in priority order. An UP or DOWN arrow in the right-most character position indicates more alarms are active, but not visible on the display. The operator can press either the UP or the DOWN arrow key to scroll through the other enabled alarms.

The operator can edit or accept variable values by pressing the ENTER key. The TD device will write the updated variable value to the CPU and set the edit notification bit for that variable when the operator presses the ENTER key. The TD device then moves the cursor to the next editable variable. Pressing ENTER for the last editable variable of an alarm writes this last value to the S7-200 CPU and the TD device then resets the alarm enable bit. For more information on editing variables, see *Editing a Variable that is Embedded in an Alarm or a Screen* in Chapter 5.

Every alarm falls into one of four possible alarm acknowledgement and editing types. This section explains specifically how each alarm type is handled by the TD device. The four alarm types follow:

- No acknowledgement required. No edits allowed
- Acknowledgement required. No edits allowed
- No acknowledgement required. Edits allowed
- Acknowledgement required. Edits allowed

No Acknowledgement Required, No Edits Allowed

In this combination of no acknowledgement required and no edits allowed, the TD device simply displays the alarm. The ENTER key has no function since there are no editable variables within the alarm. The alarm may contain variables that are updated at the update rate of the TD device. This type of alarm is replaced on the display if a higher priority alarm is enabled by the S7-200 CPU. The operator can either press the UP or the DOWN arrow key to scroll to other alarms or press ESC to return to the menus.

The TD device does not clear the corresponding alarm-enable bit in the S7-200 CPU.

Acknowledgement Required, No Edits Allowed

In this combination of acknowledgement required and no edits allowed, the TD device displays the alarm and makes the entire alarm flash (blink) until the operator presses ENTER to acknowledge the alarm. Variable values are updated from the S7-200 CPU at the normal update rate while the alarm is flashing.

When the operator presses ENTER, the TD device:

- Sets the acknowledgement-notification bit for this alarm.
- Clears the alarm-enable bit for this alarm. This causes the alarm to be removed from the display on the next update cycle.

Another alarm cannot replace the one flashing until the operator acknowledges the flashing alarm. This is also true even if a higher priority alarm is enabled in the S7-200 CPU. If the TD device is configured for single line alarms and the CPU enables a higher priority alarm, the flashing alarm shifts down to the next line of the display. The operator cannot press the UP or the DOWN key to scroll through other enabled alarms until the current alarm is acknowledged.

No Acknowledgement Required, Edits Allowed

In this combination of no acknowledgement required and edits allowed, the TD device displays a alarm and then waits for the operator to edit a value in the alarm. All of the variables within the alarm are updated at the update rate. Since the alarm does not require acknowledgement, this type of alarm is removed from the TD device display if a higher priority alarm is enabled in the S7-200 CPU.

Acknowledgement Required, Edits Allowed

In this combination of acknowledgement required and edits allowed, the TD device displays the alarm, causes the entire alarm to flash (blink), and then waits until the operator acknowledges the alarm and edits or accepts the values in the alarm. This type of alarm requires that the operator edits or accepts the values displayed in the alarm. If the operator aborts the edit by pressing the ESC key before editing all the values in the alarm, the alarm flashes to indicate that edits are still required.

When the alarm is enabled in the S7-200 CPU, the TD device notes this and, if there is space available on the display, reads the alarm from the CPU. The TD device then displays the alarm and causes the entire alarm to flash to notify the operator that the alarm is present and must be acknowledged.

Clearing an Alarm

- If an alarm required acknowledgement, the TD device will clear the alarm enable at the same time that the Alarm Acknowledgement bit is set in the CPU.
- If an alarm contains editable variables, the TD device will clear the alarm enable bit when all of the edits are completed and the last editable variable in the messages is written to the CPU.
- The PLC program logic may clear the alarm enable bit at any time. This will remove the alarm message from the TD display. An alarm message will not be removed from the display if the user is editing a variable in the message or if the message has not yet been acknowledged.
- If the message does not require acknowledgement and/or does not contain editable variables, then the CPU program logic **MUST** clear the alarm enable bit.

Editing a Variable that is Embedded in an Alarm or a Screen

If you configured a screen or an alarm to include a variable, you can enter a new value for the variable:

- Use ENTER to move the cursor to the the variable. The TD device will write the updated variable value to the CPU and set the edit notification bit for that variable when the operator presses the ENTER key, completing the edit of the variable.
- Use the UP or DOWN arrows to change the value of the variable.
- Use the following buttons to move the cursor to different characters within the variable:
 - TD 100C and TD 200C: LEFT and RIGHT arrows
 - TD 200: SHIFT+UP arrow and SHIFT+DOWN arrow
- ESC rereads the value of the variable from the S7-200 CPU and redisplay the value.
- ENTER writes the new value to the S7-200 CPU. (If the alarm contains other variables, the cursor moves to the next variable.) The TD device will write the updated variable value to the CPU and set the edit notification bit for that variable when the operator presses the ENTER key, completing the edit of the variable.

If the variable was configured as a numeric string, the cursor skips over any non-numeric characters in the message. See Chapter 4. After you have edited all of the variables in an alarm, the TD device resets the alarm bit in the S7-200 CPU.

Notice

Due to restrictions in the format used to store real (floating-point) numbers in both the S7-200 CPU and the TD device, the accuracy of the number is limited to six significant digits. Editing a real number with more than six digits may not change the value of the variable, or may cause other digits within the number to change:

- Changing the least significant (right-most) digit of a real-number variable with more than six digits may have no effect. For example, if you try to change the "9" in "1234.56789", the value of the variable does not change.
- Changing the most significant (left-most) digit of a real-number variable with more than six digits may cause other (less significant) digits in the variable to change.

TD Bit Usage

A summary of the TD bit usage is shown in Table 5-1.

Table 5-1 Summary of TD Bit Usage

Bits Associated with Alarms and Screens	Enable Condition for the Bit	Results shown on the TD Display	Clear Condition for the Bit
ALARM ENABLE	The alarm must be enabled with the TD_ALARM instruction using the Alarm Symbolic Name as the instruction input.	<p>When an alarm is enabled and the TD default display mode is set to the alarm mode, the alarm message is placed on the TD display. If there are multiple alarms enabled, the highest priority alarm is displayed.</p> <p>If an alarm requires user acknowledgment, the message will flash (blink) until it is acknowledged by the user. The alarm MUST be acknowledged before other alarms can be viewed. An alarm that requires acknowledgement will not be replaced on the display by higher priority alarms until the alarm is acknowledged.</p> <p>If the alarm contains editable variables the user can edit or accept the values (by pressing the ENTER key). If the edits are not completed, and the alarm message required acknowledgement, the message will again begin to flash.</p> <p>If the user screens are set as the default display mode for the TD device and an alarm is enabled, an alarm indicator will begin to flash on the TD display. The indicator is large if there is an alarm enabled that requires acknowledgement. The indicator will be small if the alarms do not require acknowledgement. The user can switch to the alarm display to view the alarms. The alarms will be presented to the user in priority order.</p>	<p>There are different ways to clear the alarm enable bit:</p> <p>If an alarm required acknowledgement, the TD device will clear the alarm enable at the same time that the 'Alarm Acknowledgement' bit is set in the CPU.</p> <p>If an alarm contains editable variables, the TD device will clear the alarm enable bit when all of the edits are completed and the last editable variable in the messages is written to the CPU.</p> <p>The PLC program logic may clear the alarm enable bit at any time. This will remove the alarm message from the TD display. An alarm message will not be removed from the display if the user is editing a variable in the message or if the message has not yet been acknowledged.</p> <p>If the message does not require acknowledgement and/or does not contain editable variables, then the CPU program logic MUST clear the alarm enable bit.</p>
ALARM ACKNOWLEDGE	Alarm acknowledgement is available only if the wizard configuration has the option enabled for this alarm: Alarm should require operator acknowledgement	<p>The user acknowledges an alarm message by scrolling to the message and pressing the ENTER key. The TD device will then set the acknowledge notification bit in the CPU and the alarm message will stop flashing (blinking).</p> <p>If there are no editable variables in the message the TD device will also clear the alarm enable bit for this message.</p> <p>If there are editable variables in the message, the user must either edit the variables (change them and press ENTER) or accept the current values (press ENTER). When the last variable in the message is edited or accepted, the TD device will write the variable to the CPU and clear the alarm enable bit.</p> <p>If the user does not complete editing the variables in the message, the TD device will begin to flash (blink) the message to notify the user that an action is still pending.</p>	The TD device will set the alarm acknowledge bit. The user program logic must clear the alarm acknowledgement bit.

Table 5-1 Summary of TD Bit Usage

Bits Associated with Alarms and Screens	Enable Condition for the Bit	Results shown on the TD Display	Clear Condition for the Bit
ALARM MESSAGE: EMBEDDED VARIABLE EDIT NOTIFICATION	The edit notification is available only when the alarm contains a variable and the user has enabled the Wizard option to allow editing of the variable. "Operator is allowed to edit this data". If the alarm message contains multiple editable variables, each variable has a unique edit notification bit.	The TD device will write the updated variable value to the CPU and set the edit notification bit for that variable when the operator presses the ENTER key, completing the edit of the variable.	The user program can monitor the edit notification bit to recognize when an editable value has been changed by the operator. The user program can then take some action based on the new value for the variable. The user program must clear the edit notification bit so that subsequent edits can be recognized.
USER SCREEN: EMBEDDED VARIABLE EDIT NOTIFICATION	The edit notification is available only when the user screen contains a variable and the user has enabled the Wizard option to allow editing of the variable. "Operator is allowed to edit this data". If the user screen contains multiple editable variables, each variable has a unique edit notification bit.	The TD device will write the updated variable value to the CPU and set the edit notification bit for that variable when the operator presses the ENTER key, completing the edit of the variable.	The user program can monitor the edit notification bit to recognize when an editable value has been changed by the operator. The user program can then take some action based on the new value for the variable. The user program must clear the edit notification bit so that subsequent edits can be recognized.

Performing Typical or Routine Operator Tasks

The Operator Menu allows you to perform the following tasks:

- Determining the model and version of the S7-200 CPU (CPU Status)
- Viewing the error messages generated by the S7-200 CPU (CPU Status)
- Setting the time in the S7-200 CPU (Set Time and Date)
- Selecting a language set for the TD device (Set Language) (TD 200 and TD 200C only)

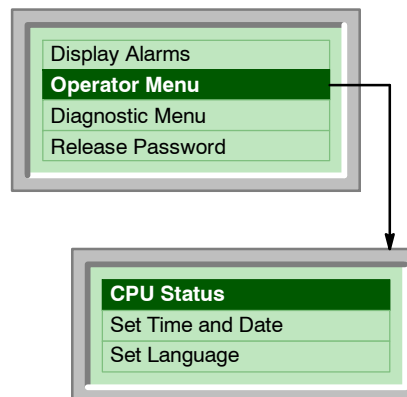

Figure 5-11 Operator Menu for TD 200C and TD 200

Viewing the Status of an S7-200 CPU

The CPU Status command allows you to display the following information:

- Model and version of the S7-200 CPU
- Error messages generated by the S7-200 CPU

After you select the CPU Status command, the TD device displays the CPU model and version.

Press the UP or DOWN arrows to display the error messages that were generated by the S7-200 CPU.

The TD device displays an error message only if an error exists in the S7-200 CPU. The CPU classifies errors as either fatal errors or non-fatal errors.

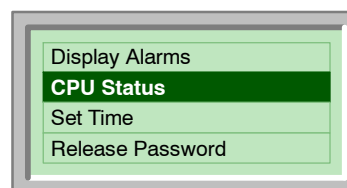

Figure 5-12 CPU Status Menu for TD 100C

Table 5-2 lists the error messages that can be displayed by the TD devices. Refer to the *SIMATIC S7-200 Programmable Controller System Manual* for information about specific errors.

Table 5-2 Error Messages Relating to the Status of the S7-200 CPU

Type	Message	Description
Fatal	Program Checksum Error	Hardware failure (S7-200 CPU)
	Compare Contact	User program error: Illegal Compare contact
	EEPROM/Permanent Memory Failure	Hardware failure (S7-200 CPU)
	Memory Cartridge Failure	Memory cartridge failure
	Scan Watchdog Timeout	Hardware failure (S7-200 CPU)
	Unknown Error XXXX (where XXXX = the error number) ¹	CPU failure (S7-200 CPU)
Non-Fatal	I/O Error Mod X (where X = the number of the I/O module)	An expansion module encountered an I/O error. If there are multiple failures, the TD device displays this message multiple times one time for each failed module.
	Runtime Error XXXX (where XXXX = the error number) ¹	The S7-200 CPU encountered an error while executing the user program, such as: <ul style="list-style-type: none"> • Indirect addressing • HSC setup and execution errors • Attempting to execute an illegal instruction (ENI, DISI, or HDEF) inside an interrupt routine • Subroutine nesting errors • TODW data errors • Simultaneous Transmit (XMT) and Receive (RCV) errors
¹ Refer to the <i>SIMATIC S7-200 Programmable Logic Controller System Manual</i> for information about the specific error.		

Setting Time and Date in the S7-200 CPU

You can use the TD device to change the time-of-day settings in the S7-200 CPU. This allows an operator to easily adjust for time changes.

The TD device does not maintain time and date settings. In order to display the time and date values, the TD device reads the current time and date from the S7-200 CPU and displays these values. The operator can then use this screen to edit these values and then write the new time and date settings back to the S7-200 CPU.



Tip

The TD device does not validate the time, date or day of the week values that you enter. You can inadvertently write an incorrect date or day of the week to the S7-200 CPU.

To allow an operator to change the time and date settings in the S7-200 CPU:

- You must have enabled (selected) the time-of-day (TOD) option when you configured the TD device with the Text Display wizard. Refer to Chapter 4.
- The S7-200 CPU must support the TOD clock.



Tip

If you configured a password for the TD device, the operator must enter the password before being allowed to set the time and date.

If the TD device was not configured to allow changes to the time or if the S7-200 CPU does not support the TOD clock, the Set Time and Date command does not appear on the Operator Menu.

After you select the Set Time command, the TD device reads the current date and time from the S7-200 CPU.

The Time and Date screen displays the following information:

- Date: day-month-year (for Chinese, the date is displayed as year-month-day)
- Time
- Day of the week

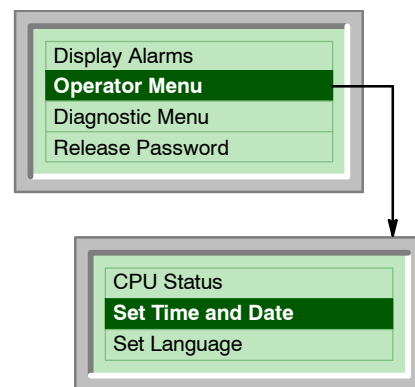

Figure 5-13 Setting the Time and Date on the TD 200C and TD 200

Use the UP or DOWN arrow buttons to change the values in the fields.

Use the ENTER to move to the next field. (For a TD 100C and TD 200C, you can also use the RIGHT arrow. For a TD 200, you can use the SHIFT+DOWN arrow.)

Use the ESC to move back to the first field. (For a TD 100C and TD 200C, you can also use the LEFT arrow. For a TD 200, you can use the SHIFT+UP arrow.)

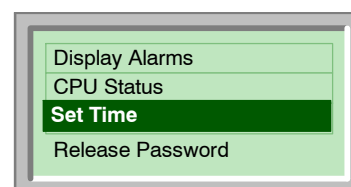

Figure 5-14 Setting the Time and Date on the TD 100C

Pressing ENTER when the cursor is located on the last field of the Time and Date screen writes the new time and date values to the S7-200 CPU and returns to the Operator Menu.

Pressing ESC when the cursor is located on the first field of the Time and Date screen returns to the Operator Menu.

Changing the Language Set (TD 200C and TD 200 only)

You can use the TD device to change the language set in order to localize the TD device for another country. You must have created different language sets for your alarms and screens when you configured the TD device with the Text Display wizard. Each language set that you configure selects the language for the system menus and prompts of the TD device, as well as the screens and alarms. Refer to Chapter 4 for information about configuring language sets for the TD device.

As shown in Figure 5-15, selecting the Set Language command displays a menu of the languages that you configured with the Text Display wizard. Use the UP or DOWN arrows to select the language to be displayed by the TD device.

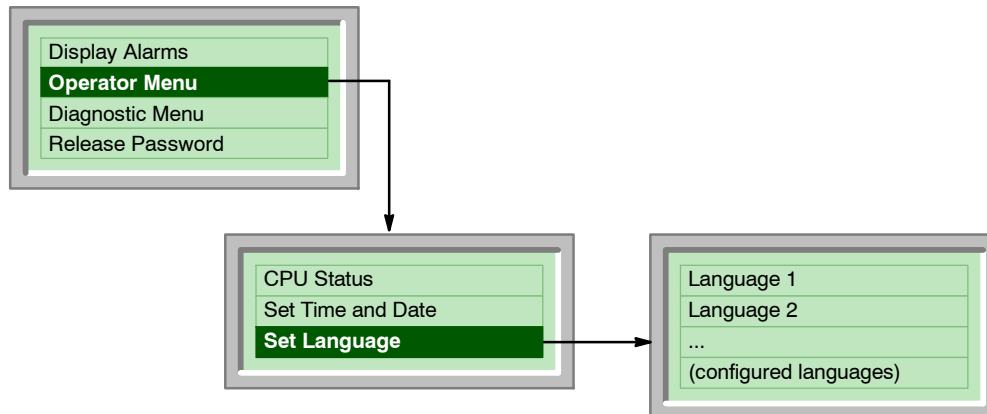

Figure 5-15 Selecting One of the Language Sets Configured for the TD Device

Cleaning the Keypad

The Clean Keypad function disables the keypad for 30 seconds to allow you to clean the keypad without affecting TD operation. The TD device displays a count down timer that shows the remaining seconds.

Performing Specialized Operator Tasks (Diagnostic/Setup Menu)

Some of the pre-configured tasks provided by the TD device provide assistance with setting up the TD device or troubleshooting problems with the S7-200 CPU. These functions are typically accessed infrequently. See Figure 5-16 and Figure 5-17.

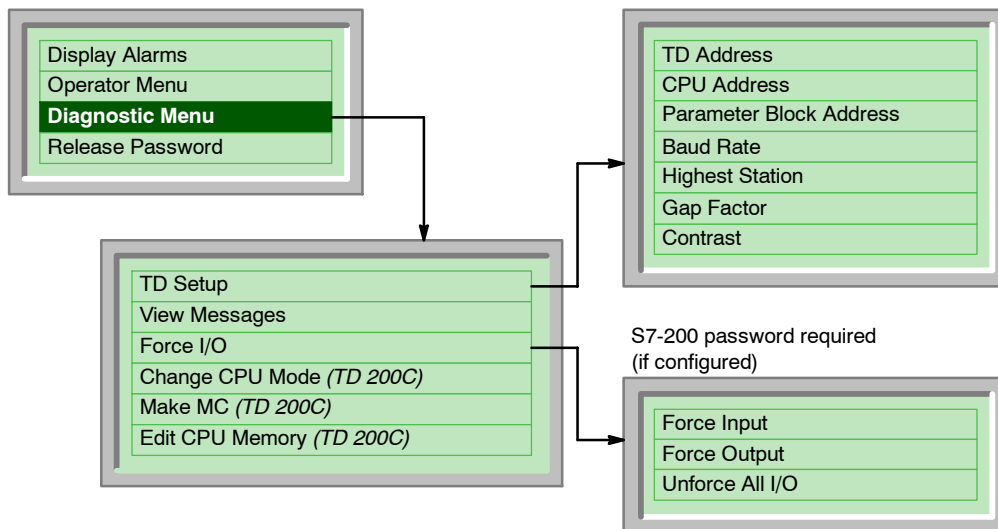

Figure 5-16 TD 200C and TD 200 Diagnostic Menu Hierarchy

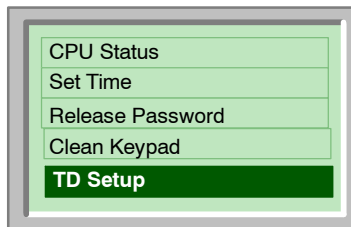

Figure 5-17 TD 100C Diagnostic Menu Hierarchy



Tip

If you are using a custom keypad that does not support the ENTER and ESC buttons, you must use the standard keypad to set up the TD device.

To restore the standard TD keypad:

1. Power down the TD device
2. Press and hold the lower right corner (where ENTER key is located on the standard keypad)
3. Power up the TD device

The default keypad is restored until the TD device is power cycled again.

Setting up the TD Device

As shown in Figure 5-18, you use the TD Setup menu to configure various parameters for the TD device, such as network addresses, address of the parameter block (stored in V memory of the S7-200 CPU), baud rate, and other communication parameters.

- Setting the network address for the TD device: Use the UP or DOWN arrow to set the network address (default address = 1).
- Setting the CPU address: Use the UP or DOWN arrow to select the network address for the S7-200 CPU (default = 2).
- Setting the address for the parameter block: Designates a V memory location where the parameter block (or an offset to the location of the parameter block) is stored in the S7-200 CPU. Setting the address of the parameter block allows you to connect multiple TD devices to a single S7-200 CPU.

Use the UP or DOWN arrow to select the starting V memory address of the parameter block that stores the configuration of the TD device.

The address of the parameter block must match the address that you configured in the S7-200 CPU (address range: VB0 to VB32000, default = VB0).

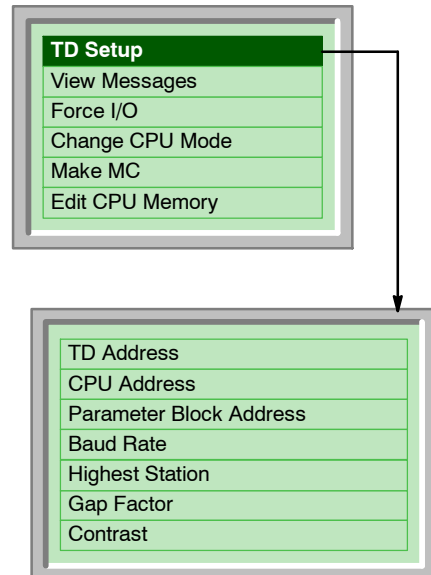

Figure 5-18 TD Setup Menu

- Setting the baud rate for the TD device: choose the baud rate for the TD device. You can choose either 9.6 kbaud (9600 baud), 19.2 kbaud, or 187.5 kbaud.

Use the UP or DOWN arrow to select the baud rate. The baud rate must match the baud rate of the S7-200 CPU and any other device on the same network.

- Setting the Highest Station: Changes the highest station address for the TD device. This setting tells the TD device which network addresses to check when looking for other network master devices. The default highest station address is 31. This means that the TD device checks addresses 0 through 31 when looking for other network masters. This setting should only be changed when there are more than 32 master devices on the network.

Use the UP and DOWN arrows to select the highest address on the network (default = 31)

- Setting the Gap Factor: Changes the Gap Factor for the TD device. This setting tells the TD device how often to check for other network master devices. The default setting of 10 causes the TD device to check once every 10 messages. A setting of 1 would cause the TD device to check for other masters after every message.

Use the UP and DOWN arrows to select the gap factor between stations (default = 10)

- Set the contrast: You can optimize the display for different viewing angles and lighting conditions by adjusting the contrast of the screen on the TD device. The default contrast value is 40, with values ranging from 25 (lighter) to 55 (darker).

Use the UP and DOWN arrows to select the contrast setting for the display area of the TD device (default setting = 40)



Tip

At 9600 baud or 19.2 kbaud, the highest station address may need to be increased, even though the network does not contain more than 32 masters. Increasing the highest station address allows more time for the masters to transmit messages.

Viewing the TD Messages Stored in the S7-200 CPU (TD 200C, TD 200 only)

You can review all of the TD messages (screens and alarms) that you configured for the TD device within the language set currently selected for the TD device.

The View Messages command allows you to verify that all of the alarms and screens were correctly stored in the S7-200 CPU.

The View Messages command does not allow you to edit any values that are displayed in the messages.

Selecting the View Messages command displays all of the messages and process values stored in the S7-200 CPU. Use the UP and DOWN arrows to scroll through messages stored in the S7-200 CPU.

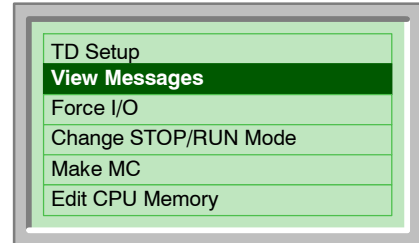

Figure 5-19 View Messages Command

Forcing the Inputs and Outputs in the S7-200 CPU (TD 200C, TD 200 only)

The Force I/O menu allows you to force inputs, force outputs, or unforce all inputs and outputs. The Force I/O command is available only if you enabled the force-menu when you configured the TD device with the Text Display wizard.

Caution

Turning off the power to the S7-200 CPU before the force information is written to the permanent memory in the CPU can cause the S7-200 CPU to experience a failure the next time you turn the S7-200 CPU on.

To clear the error condition, use the TD device to either unforce all of the I/O points or else rewrite the force information to the S7-200 CPU. Cycling the power to the S7-200 CPU should clear the error.

If the S7-200 CPU requires a password before allowing the I/O to be forced, the TD device prompts the operator to enter the 8-character CPU password.

The Force I/O command provides the following options:

- Force Inputs: Allows you to force individual inputs on or off, or to turn off the Force function
- Force Outputs: Allows you to force individual outputs on or off, or to turn off the Force function
- Unforce All I/O: Allows you to turn off the Force function for all of the forced I/O points

Use the UP or DOWN arrow to select the specific I/O point. Pressing ENTER moves the cursor to the Force options. (For a TD 200C, you can also use the RIGHT arrow. For a TD 200, you can use the SHIFT+DOWN arrow.)

Use the UP or DOWN arrow to select the type of force condition for the selected I/O point.

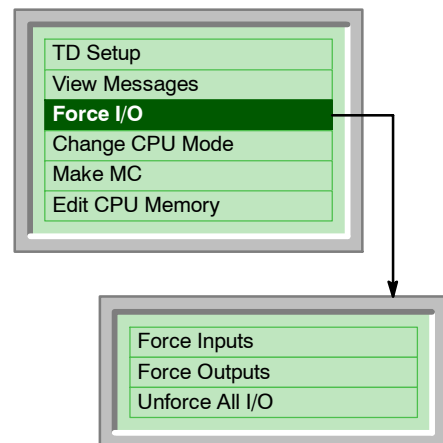

Figure 5-20 Force I/O Command



Tip

Unforcing the I/O points does not place them in the OFF state. Unforcing only removes the Force option. The points remain in their last state until you manually change them or they are changed by the user program in the S7-200 CPU.

Changing the Operating Mode of the S7-200 CPU (TD 200C Only)

The Change STOP/RUN Mode command is only available for the TD 200C and is only available if you selected this function when you configured the TD 200C with the Text Display wizard. See Chapter 4.

You can use the TD 200C to change the operating mode of the S7-200 CPU from STOP to RUN or from RUN to STOP. The operator may need to enter the TD password, if the TD 200C is configured for password-protection.

In order to allow the TD 200C to change the operating mode, the mode selector switch on the S7-200 must be set to either RUN or TERM.

The TD 200C cannot change the operating mode if the mode selector switch is set to STOP.

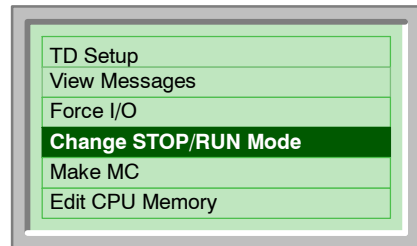

Figure 5-21 Changing the Operating Mode

Copying the User Program to a Memory Cartridge (TD 200C Only)

The Make MC (memory cartridge) command is only available for the TD 200C and only if you selected this function when you configured the TD 200C with the Text Display wizard. See Chapter 4.

You can use the TD 200C to copy the user program in the S7-200 CPU to a memory cartridge (MC). The operator may need to enter both the TD password and the CPU password, if both the TD 200C and the S7-200 CPU are configured for password-protection.

Before attempting to write the user program to the memory cartridge, ensure that you have installed a memory cartridge in the S7-200 CPU.

After you select the Make MC command, the TD 200C alerts you that this operation will erase any existing data on the memory cartridge. Press the DOWN arrow to continue.

After reading the message, press ENTER to continue or press ESC to abort the operation.

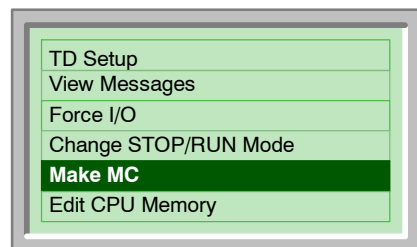

Figure 5-22 Making a Memory Cartridge

Editing the CPU Memory (TD 200C Only)

The Edit CPU Memory command is only available for the TD 200C and only if you selected this function when you configured the TD 200C with the Text Display wizard. See Chapter 4.

You can use the TD 200C to edit the values stored in the memory of the S7-200 CPU. The operator may need to enter the TD password, if the TD 200C is configured for password-protection.

After you select the Edit CPU Memory command (Figure 5-23), the TD 200C displays the Edit CPU Memory screen.

As shown in Figure 5-24, you press ESC to edit the data in the memory address. The TD 200C places a cursor on the memory area.

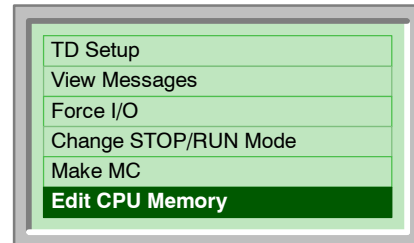

Figure 5-23 Edit CPU Memory Command

- To edit the memory address: Use the UP or DOWN arrows to change the memory address. (Use the RIGHT or LEFT arrow keys to move between the fields of the memory address.) Press ENTER to display the value of that memory address and to move the cursor to the data type field.
- To edit the data type: Use the UP or DOWN arrows to change the data type. Press ENTER to display the value and to move the cursor to the value field.
- To edit the value stored in the memory address: Use the UP or DOWN arrows to change the value.

Press ENTER to write the new values to the memory address in the S7-200 CPU. Pressing ESC aborts the function.

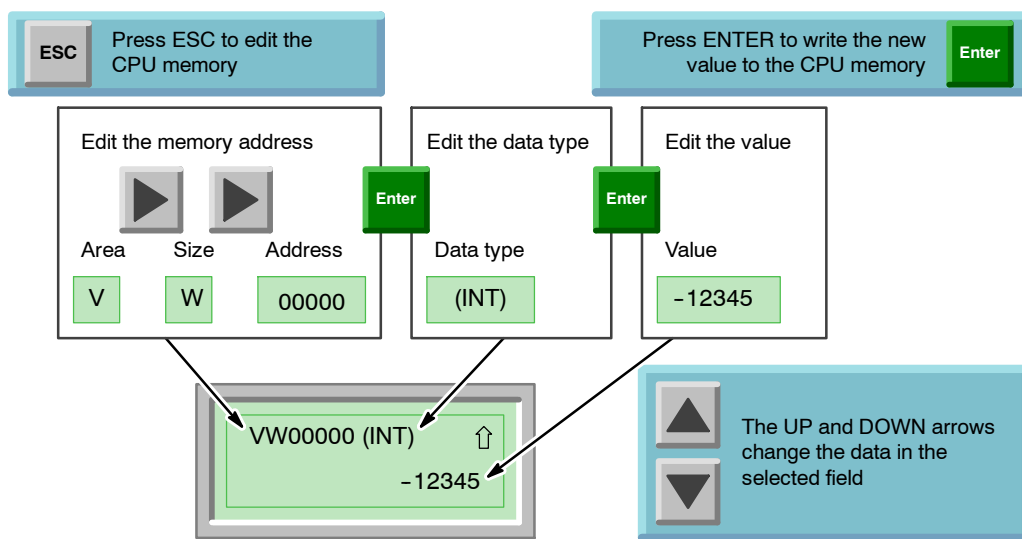

Figure 5-24 Editing the Memory in the S7-200 CPU

Table 5-3 lists the memory address and data types possible. For information about the memory areas, sizes of the data, and data types supported by your S7-200 CPU, refer to the *S7-200 Programmable Controller System Manual*.

Use the UP and DOWN arrows to scroll through the list of valid entries for each field.

To change the numeric value displayed in the address and value fields:

- Use the UP and DOWN arrows to adjust each digit in the value or address.
- Use the LEFT and RIGHT arrows to move between the digits of the value or address.
- Press ENTER to write the new value to the S7-200 CPU.



Tip
Binary values cannot be edited.

Table 5-3 Possible Values for the CPU Memory Address and Data Type

Field	Description
Memory area	V Variable memory area M Bit Memory area SM Special Memory area T Timers Current value only ¹ , INT only C Counters Current value only ¹ , INT only I Inputs Q Outputs
Memory size	B (byte) W (word) D (double-word)
Address	0 to 32000 (limited by the memory for your S7-200 CPU) Refer to the <i>S7-200 Programmable Controller System Manual</i> for the range of memory supported by the different S7-200 CPU models)
Data type	INT Integer (valid for Byte, Word or Double-word) Byte values are displayed as unsigned integers Word and Double-word values are displayed as signed integers REAL Real or floating-point (valid for Double-word only) The value displayed for a Real number is rounded to 6 or 7 significant digits. The TD 200C displays the Real number in fixed-point format only (no scientific notation) The TD 200C cannot display Real numbers larger than 18 digits and allows up to 7 decimal places. (For example: The TD 200C displays 0.00000005 as 0.0000001, and displays real numbers less than 0.00000005 as "0.0".) The TD 200C writes the number displayed to the S7-200 CPU without rounding. HEX Hexadecimal (valid for Byte, Word, and Double-word) BIN Binary (valid for Byte and Word only) Binary values are displayed in the same pattern (7..0) as discussed in the <i>S7-200 Programmable Controller System Manual</i> and displayed by the Status Chart of STEP 7-Micro/WIN Binary values cannot be edited

¹ The TD 200C displays only the current value for timers and counters. To display preset values for timers or counters, you must store these values in V memory. The TD 200C does not display the value of the timer or counter bit.

Technical Specifications and Reference Information



In This Chapter

General Technical Specifications	90
Certificates, Directives and Declarations	92
IEC 61131-2	92
Notes on the CE Symbol	92
EMC Directive	92
ATEX Directive (Explosion Protection Guidelines)	92
Declaration of Conformity	92
Observing the Setup Guidelines	92
Approvals for USA, Canada and Australia	93
FM Approval Notes	93
Standard TD Character Set (TD 200C, TD 200 only)	94
ALT Key Combinations for International and Special Characters	95
Bar Graph Character Set (TD 200C, TD 200 only)	96
Arabic Character Set (TD 200C, TD 200 only)	97
Baltic Character Set	98
Simplified Chinese Character Set	99
Notes for Using the Simplified Chinese Character Set	99
Cyrillic Character Set	100
Greek Character Set	101
Hebrew Character Set (TD 200C, TD 200 only)	102
Latin 1 Character Set	103
Latin 2 Character Set	104
Turkish (Latin 5) Character Set	105

General Technical Specifications

Table A-1 Text Display Order Numbers

Order Number	Description	Dimensions (mm) (W x H x D)	Weight
6ES7 272-1BA10-0YA0	TD 100C Operator Interface	89.6 x 76 x 35.7	0.11 kg
6ES7 272-0AA30-0YA0	TD 200 Operator Interface	148 x 76 x 28	0.19 kg
6ES7 272-1AA10-0YA0	TD 200C Operator Interface	148 x 76 x 28	0.20 kg
6ES7 272-1AF00-7AA0	TD 200C Blank faceplate material, A4 size (10 sheets/package)		
6ES7 272-1BF00-7AA0	TD 100C Blank faceplate material, A4 size (10 sheets/package)		
6ES7 901-3EB10-0XA0	TD/CPU cable ¹	3 meters	0.15 kg

¹ If the TD 100C is purchased inside North America, the TD CPU cable is included with the TD 100C. If the TD 100C is purchased outside North America, the cable must be ordered separately.

Table A-2 General Specifications

General	TD 100C 6ES7 272-1BA10-0YA0	TD 200 6ES7 272-0AA30-0YA0	TD 200C 6ES7 272-1AA10-0YA0
Keyboard	Customizable faceplate Supports up to 14 keys	Membrane keypad with 9 keys; Tab inserts for customer-specific labeling	Customizable faceplate Supports up to 20 keys
Display	FSTN-Graphic Display with 132 x 65 (columns x rows), no backlight	STN-Graphic Display with 181 x 33 (Columns x Rows), LED backlight	
PLC interface	RS 485 (PPI); 9.6 / 19.2 / 187.5 Kbits/s		
Supply voltage (U _N)	Supplied by the S7-200 CPU, no external supply, (24 VDC (8 VDC ... 30 VDC) safety extra low voltage, NEC Class 2 or limited power source)	24 VDC, 15 VDC ... 30 VDC, safety extra low voltage, NEC Class 2 or limited power source (supplied by the S7-200 CPU, mains adapter or a 24 VDC external supply). The TD device has no integrated means of protection against strong interference pulses in the microsecond range (surge impulse). If the power being supplied has no appropriate means of protection, then a surge voltage protector should be pre-connected.	
Current consumption (I _N)	Typical 20 mA, maximum 50 mA, at U _N 24V (no fuse in TD 100C)	Typical 70 mA, (terminating resistors switched off) Maximum 120 mA at U _N 24V (3.15A fuse in TD 200).	
Inrush current	Not applicable	Maximum 0.6 A / 15 ms	
Degree of protection	IP 65 ¹ (mounted on front of the panel) IP 20 (mounted on casing) UL 50 Type 4X ¹	IP 65 ² (mounted on front of the panel) IP 20 (mounted on casing) UL 50 Type 4X ²	
Safety			
Safety standard	IEC61131-2, UL508, CSA C22.2 No. 142	EN 60950, IEC 60950, UL 60950, CSA C22.2 No. 60950	
Noise emission	<45dB(A) to DIN 45635 (no fan)		
<p>¹ To ensure compliance of the TD 100C with IP 65 and UL 50 Type 4X, you must follow these guidelines. The minimum panel thickness must be at least 1.5 mm. The mounting screws on the TD 100C device must be tightened to a torque of 0.2 Nm (about 0.5 mm the height of the seal). The gasket must be replaced whenever the TD device is removed and reinstalled. To procure new gaskets, contact your Siemens distributor or sales representative.</p> <p>² To ensure compliance of the TD 200C and TD 200 with IP 65 and UL 50 Type 4X, you must follow these guidelines. The minimum panel thickness must be at least 1.5 mm. The mounting screws on the TD 200C or TD 200 device must be tightened to a torque of 0.7 N-m. The gasket must be replaced whenever the TD device is removed and reinstalled. To procure new gaskets, contact your Siemens distributor or sales representative.</p>			

Certificates, Directives and Declarations

IEC 61131-2

The TD 100C text display satisfies the requirements and criteria of the IEC 61131-2 standard (programmable controllers, part 2 on equipment requirements and tests).

Notes on the CE Symbol

The following applies to the SIMATIC product described in this operating instruction:



EMC Directive

This product fulfils the requirements for the EC directive 89/336/EEC on “electromagnetic compatibility” and the following fields of application apply according to this CE symbol. See Table A-3.

Table A-3 EMC Directive

Field of Application	Requirement for	
	Emitted Interference	Noise Immunity
Residential, commercial areas and light industrial environments	EN 61000-6-3	EN 61000-6-1
Industry	EN 61000-6-4	EN 61000-6-2

ATEX Directive (Explosion Protection Guidelines) (TD 200C and TD 200 only)

The TD 200C and TD 200 devices fulfill the requirements for the EC directive 94/9/EEC on “ATEX” (Devices and protection systems to be used as prescribed in potentially explosive areas (Guidelines for Explosion Protection)) and was tested according to EN 50021 (Electrical apparatus for potentially explosive atmospheres; Type of protection “n”).



II 3 G EEx nA II T3..T6

Declaration of Conformity

The EC declarations of conformity and the documentation relating to this are available to the authorities concerned, according to the above EC directive, from:

Siemens AG
 Bereich Automatisierungs- und Antriebstechnik
 A&D AS RD ST
 Postfach 1963
 D-92209 Amberg

Tel.: 09621 80 3283
 Fax: 09621 80 3278

Observing the Setup Guidelines

The setup guidelines and notes on safety given in the manual must be observed on startup and during operation.

Certificates, Directives and Declarations

IEC 61131-2

The TD 100C text display satisfies the requirements and criteria of the IEC 61131-2 standard (programmable controllers, part 2 on equipment requirements and tests).

Notes on the CE Symbol

The following applies to the SIMATIC product described in this operating instruction:



EMC Directive

This product fulfils the requirements for the EC directive 89/336/EEC on “electromagnetic compatibility” and the following fields of application apply according to this CE symbol. See Table A-3.

Table A-3 EMC Directive

Field of Application	Requirement for	
	Emitted Interference	Noise Immunity
Residential, commercial areas and light industrial environments	EN 61000-6-3	EN 61000-6-1
Industry	EN 61000-6-4	EN 61000-6-2

ATEX Directive (Explosion Protection Guidelines) (TD 200C and TD 200 only)

The TD 200C and TD 200 devices fulfill the requirements for the EC directive 94/9/EEC on “ATEX” (Devices and protection systems to be used as prescribed in potentially explosive areas (Guidelines for Explosion Protection)) and was tested according to EN 50021 (Electrical apparatus for potentially explosive atmospheres; Type of protection “n”).



 II 3 G EEx nA II T3..T6

Declaration of Conformity

The EC declarations of conformity and the documentation relating to this are available to the authorities concerned, according to the above EC directive, from:

Siemens AG
Bereich Automatisierungs- und Antriebstechnik
A&D AS RD ST
Postfach 1963
D-92209 Amberg

Tel.: 09621 80 3283
Fax: 09621 80 3278

Observing the Setup Guidelines

The setup guidelines and notes on safety given in the manual must be observed on startup and during operation.

Approvals for USA, Canada and Australia

The characters stamped on a device are indicative of the requirements which that device meets:

Underwriters Laboratories: cULus Approval, Hazardous Location

CULUS Listed 21BP I.T.E. for Hazardous Location
Underwriters Laboratories Inc., according to:



- TD 200 and TD 200C:
UL 60950 (Information Technology)
CSA C22.2 No. 60950 (Information Technology)
- TD 100C:
UL 508 (Industrial Control Equipment)
CSA C22.2 No. 142 (Industrial Control Equipment)
UL 1604 (Hazardous Location)
CSA-213 (Hazardous Location)

APPROVED for Use in:

- Cl. 1, Div.2, GP. A, B, C, D, T5
- Cl. 1, Zone 2, GP.IIC, T5

Please see the note below:

Note:

This plant has to be mounted according to the NEC (National Electric Code) stipulations.

When used in environments according to class I, division 2 (see above), the SIMATIC TD device must be mounted in a housing that corresponds to at least IP54 according to EN 60529.

FM approval to Factory Mutual Approval Standard Class Number 3611, Class I, Division 2, Group A, B, C, D, and Class I, Zone 2, Group IIC.
Temperature class T5 is adhered to when the ambient temperature during operation does not exceed 60°C.



Note for Australia: Our product fulfills the requirements for Norm AS/NZS CISPR22.



FM Approval Notes

FM approval, if present, is to Factory Mutual Approval Standard Class Number 3611, Class I, Division 2, Group A, B, C, D, and Class I, Zone 2, Group IIC.

Temperature class T5 is adhered to when the ambient temperature during operation does not exceed 60°C.



Warning

Personal injury or property damage can result if you do not follow FM hazardous location guidelines.

In hazardous areas, personal injury or property damage can result if you close or disconnect an electrical circuit during operation (for example, plug-in connections, fuses, switches).

Do not close or disconnect any live circuits unless explosion hazards can be definitely excluded.
Do not disconnect while the circuit is live unless the location is known to be non-hazardous.

Standard TD Character Set (TD 200C, TD 200 only)

Table A-4 Standard TD Character Set for the TD 200C and the TD 200

Char	Hex	Dec	Char	Hex	Dec	Char	Hex	Dec	Char	Hex	Dec	Char	Hex	Dec
	20	32	M	4D	77	z	7A	122	ƒ	A7	167	ƒ	D4	212
!	21	33	N	4E	78	{	7B	123	í	A8	168	I	D5	213
"	22	34	O	4F	79		7C	124	ú	A9	169	Э	D6	214
#	23	35	P	50	80	}	7D	125	I	AA	170	̄	D7	215
\$	24	36	Q	51	81	→	7E	126	†	AB	171	リ	D8	216
%	25	37	R	52	82	←	7F	127	†	AC	172	ℓ	D9	217
&	26	38	S	53	83		80	128	l	AD	173	ℓ	DA	218
'	27	39	T	54	84	ü	81	129	Э	AE	174	□	DB	219
(28	40	U	55	85		82	130	ʝ	AF	175	ʝ	DC	220
)	29	41	V	56	86		83	131	-	B0	176	ʝ	DD	221
*	2A	42	W	57	87	ä	84	132	ƒ	B1	177	°	DE	222
+	2B	43	X	58	88		85	133	í	B2	178	°	DF	223
,	2C	44	Y	59	89		86	134	ú	B3	179	α	E0	224
-	2D	45	Z	5A	90		87	135	I	B4	180	β	E1	225
.	2E	46	[5B	91		88	136	†	B5	181	β	E2	226
/	2F	47	¥	5C	92		89	137	‡	B6	182	e	E3	227
0	30	48]	5D	93		8A	138	‡	B7	183	μ	E4	228
1	31	49	^	5E	94		8B	139	ʝ	B8	184	σ	E5	229
2	32	50	_	5F	95		8C	140	ƒ	B9	185	ρ	E6	230
3	33	51	`	60	96		8D	141	□	BA	186	g	E7	231
4	34	52	a	61	97	ä	8E	142	‡	BB	187	√	E8	232
5	35	53	b	62	98		8F	143	ʝ	BC	188	-¹	E9	233
6	36	54	c	63	99	æ	90	144	λ	BD	189	j	EA	234
7	37	55	d	64	100	Æ	91	145	ƒ	BE	190	x	EB	235
8	38	56	e	65	101	ss	92	146	ʝ	BF	191	‡	EC	236
9	39	57	f	66	102	â	93	147	‡	C0	192		ED	237
:	3A	58	g	67	103	ö	94	148	ƒ	C1	193	ñ	EE	238
;	3B	59	h	68	104	Å	95	149	ʝ	C2	194	ö	EF	239
<	3C	60	I	69	105		96	150	ƒ	C3	195	p	F0	240
=	3D	61	j	6A	106		97	151	†	C4	196	q	F1	241
>	3E	62	k	6B	107		98	152	†	C5	197	θ	F2	242
?	3F	63	l	6C	108	ö	99	153	ƒ	C6	198	∞	F3	243

Table A-4 Standard TD Character Set for the TD 200C and the TD 200, continued

Char	Hex	Dec	Char	Hex	Dec	Char	Hex	Dec	Char	Hex	Dec	Char	Hex	Dec
@	40	64	m	6D	109	ü	9A	154	ɹ	C7	199	Ω	F4	244
A	41	65	n	6E	110		9B	155	ʒ	C8	200	ù	F5	245
B	42	66	o	6F	111		9C	156	/	C9	201	Σ	F6	246
C	43	67	p	70	112		9D	157	Λ	CA	202	Π	F7	247
D	44	68	q	71	113		9E	158	ƚ	CB	203		F8	248
E	45	69	r	72	114		9F	159	7	CC	204	Å	F9	249
F	46	70	s	73	115		A0	160	^	CD	205		FA	250
G	47	71	t	74	116	□	A1	161	ƚ	CE	206	æ	FB	251
H	48	72	u	75	117	ƚ	A2	162	ɹ	CF	207	Æ	FC	252
I	49	73	v	76	118	┘	A3	163	ˆ	D0	208	ss	FD	253
J	4A	74	w	77	119	,	A4	164	À	D1	209	å	FE	254
K	4B	75	x	78	120	•	A5	165	ʌ	D2	210	■	FF	255
L	4C	76	y	79	121	7	A6	166	ƚ	D3	211			

ALT Key Combinations for International and Special Characters

Certain international and special characters may not display correctly on the TD display if entered with the Text Display wizard with the standard TD character set. For international and special characters, use the ALT key and number combinations shown in Table A-5 to enter the characters in the Text Display wizard.

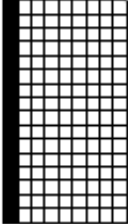
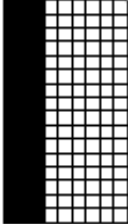
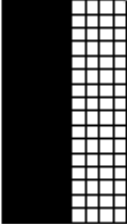
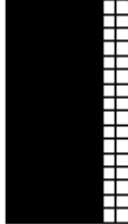

Table A-5 ALT Key Combinations for International and Special Characters

Character	ALT + Key Combination	Character	ALT + Key Combination
ü	Alt+0129	ñ	Alt+0164
ä	Alt+0132	Ω	Alt+0234
æ	Alt+0145	Σ	Alt+0228
Æ	Alt+0146	Π	Alt+0227
å	Alt+0134	¥	Alt+0157
ö	Alt+0148	←	Alt+0195 (left arrow ←)
Å	Alt+0143	→	Alt+0180 (right arrow →)
°	Alt+0248		Alt+0200 (single bar)
α	Alt+0224		Alt+0201 (double bar)
β	Alt+0225		Alt+0202 (triple bar)
ε	Alt+0238		Alt+0203 (four bars)
μ	Alt+0230		Alt+0204 (five bars)
σ	Alt+0229	↑	Alt+0194 (up arrow)
¢	Alt+0155		

Bar Graph Character Set (TD 200C, TD 200 only)

Table A-6 shows the bar graph characters that are supported by the standard TD character set.

Table A-6 Bar Graph Character Set for the TD 200C and TD 200

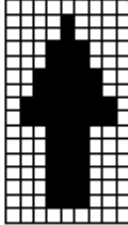
					
0x90 0xFB	0x91 0xFC	0x92 0xFD	0x93 0xFE	0xFF	0x95 0xF9

Arabic Character Set (TD 200C, TD 200 only)

Table A-7 Arabic Character Set for the TD 100C, TD 200 and TD 200C

Char	Hex	Dec	Char	Hex	Dec	Char	Hex	Dec	Char	Hex	Dec	Char	Hex	Dec
	20	32	M	4D	77	z	7A	122	§	A7	167	ش	D4	212
!	21	33	N	4E	78	{	7B	123	¨	A8	168	ص	D5	213
"	22	34	O	4F	79		7C	124	©	A9	169	ض	D6	214
#	23	35	P	50	80	}	7D	125	ھ	AA	170	×	D7	215
\$	24	36	Q	51	81	~	7E	126	«	AB	171	ط	D8	216
%	25	37	R	52	82	€	80	128	¬	AC	172	ظ	D9	217
&	26	38	S	53	83	پ	81	129	-	AD	173	ع	DA	218
'	27	39	T	54	84	،	82	130	®	AE	174	غ	DB	219
(28	40	U	55	85	،	83	131	™	AF	175	.	DC	220
)	29	41	V	56	86	،	84	132	°	B0	176	ف	DD	221
*	2A	42	W	57	87	،	85	133	±	B1	177	ق	DE	222
+	2B	43	X	58	88	...	86	134	²	B2	178	ك	DF	223
,	2C	44	Y	59	89	†	87	135	³	B3	179	à	E0	224
-	2D	45	Z	5A	90	‡	88	136	´	B4	180	ج	E1	225
.	2E	46	[5B	91	^	89	137	µ	B5	181	â	E2	226
/	2F	47	\	5C	92	‰	8A	138	¶	B6	182	م	E3	227
0	30	48]	5D	93	ث	8B	139	·	B7	183	ن	E4	228
1	31	49	^	5E	94	<	8C	140	،	B8	184	هـ	E5	229
2	32	50	~	5F	95	œ	8D	141	¡	B9	185	و	E6	230
3	33	51	`	60	96	ع	8E	142	:	BA	186	ç	E7	231
4	34	52	a	61	97	ز	8F	143	»	BB	187	è	E8	232
5	35	53	b	62	98	ط	90	144	¼	BC	188	é	E9	233
6	36	54	c	63	99	گ	91	145	½	BD	189	ê	EA	234
7	37	55	d	64	100	،	92	146	¾	BE	190	ë	EB	235
8	38	56	e	65	101	،	93	147	¿	BF	191	ی	EC	236
9	39	57	f	66	102	”	94	148	^	CO	192	ي	ED	237
:	3A	58	g	67	103	”	95	149	ء	C1	193	أ	EE	238
;	3B	59	h	68	104	•	96	150	آ	C2	194	إ	EF	239
<	3C	60	I	69	105	-	97	151	أ	C3	195	=	FO	240
=	3D	61	j	6A	106	—	98	152	ؤ	C4	196	°	F1	241
>	3E	62	k	6B	107	ك	99	153	إ	C5	197	=	F2	242
?	3F	63	l	6C	108	™	9A	154	س	C6	198	=	F3	243
@	40	64	m	6D	109	ط	9B	155	ا	C7	199	ô	F4	244
A	41	65	n	6E	110	>	9C	156	ب	C8	200	°	F5	245
B	42	66	o	6F	111	œ	9D	157	ة	C9	201	.	F6	246
C	43	67	p	70	112		9E	158	ت	CA	202	+	F7	247
D	44	68	q	71	113		9F	159	ث	CB	203	°	F8	248
E	45	69	r	72	114	ب	A0	160	ج	CC	204	ù	F9	249
F	46	70	s	73	115		A1	161	ح	CD	205	°	FA	250
G	47	71	t	74	116	،	A2	162	غ	CE	206	û	FB	251
H	48	72	u	75	117	‡	A3	163	د	CF	207	ü	FC	252
I	49	73	v	76	118	£	A4	164	ذ	D0	208		FD	253
J	4A	74	w	77	119	¥	A5	165	ر	D1	209		FE	254
K	4B	75	x	78	120	¥	A6	166	ز	D2	210		FF	255
L	4C	76	y	79	121				س	D3	211			

Baltic Character Set

Table A-8 Baltic Character Set for the TD 100C, TD 200 and TD 200C

Char	Hex	Dec	Char	Hex	Dec	Char	Hex	Dec	Char	Hex	Dec	Char	Hex	Dec
	20	32	M	4D	77	z	7A	122	š	A7	167	ō	D4	212
!	21	33	N	4E	78	{	7B	123	ø	A8	168	õ	D5	213
"	22	34	O	4F	79		7C	124	©	A9	169	ö	D6	214
#	23	35	P	50	80	}	7D	125	ŕ	AA	170	×	D7	215
\$	24	36	Q	51	81	~	7E	126	«	AB	171	ŭ	D8	216
%	25	37	R	52	82	€	7F	127	¬	AC	172	ł	D9	217
&	26	38	S	53	83	€	80	128	-	AD	173	ś	DA	218
'	27	39	T	54	84		81	129	®	AE	174	ū	DB	219
(28	40	U	55	85	,	82	130	Æ	AF	175	ü	DC	220
)	29	41	V	56	86	,	83	131	°	B0	176	ž	DD	221
*	2A	42	W	57	87	„	84	132	±	B1	177	ž	DE	222
+	2B	43	X	58	88	...	85	133	²	B2	178	β	DF	223
,	2C	44	Y	59	89	†	86	134	³	B3	179	ą	E0	224
-	2D	45	Z	5A	90	‡	87	135	´	B4	180	ı	E1	225
.	2E	46	[5B	91		88	136	μ	B5	181	ā	E2	226
/	2F	47	\	5C	92	‰	89	137	¶	B6	182	ć	E3	227
0	30	48]	5D	93		8A	138	·	B7	183	ä	E4	228
1	31	49	^	5E	94	<	8B	139	ø	B8	184	å	E5	229
2	32	50	_	5F	95		8C	140	ı	B9	185	ę	E6	230
3	33	51	`	60	96	˙	8D	141	ŕ	BA	186	ē	E7	231
4	34	52	a	61	97	˘	8E	142	»	BB	187	č	E8	232
5	35	53	b	62	98	,	8F	143	¼	BC	188	é	E9	233
6	36	54	c	63	99	,	90	144	½	BD	189	z	EA	234
7	37	55	d	64	100	‘	91	145	¾	BE	190	é	EB	235
8	38	56	e	65	101	’	92	146	æ	BF	191	g	EC	236
9	39	57	f	66	102	“	93	147	À	C0	192	ķ	ED	237
:	3A	58	g	67	103	”	94	148	Ā	C1	193	ī	EE	238
;	3B	59	h	68	104	•	95	149	Ă	C2	194	ĵ	EF	239
<	3C	60	I	69	105	–	96	150	Ć	C3	195	š	FO	240
=	3D	61	j	6A	106	—	97	151	Ä	C4	196	ń	F1	241
>	3E	62	k	6B	107		98	152	Å	C5	197	ŋ	F2	242
?	3F	63	l	6C	108	™	99	153	Ę	C6	198	ó	F3	243
@	40	64	m	6D	109		9A	154	Ě	C7	199	ō	F4	244
A	41	65	n	6E	110	>	9B	155	Č	C8	200	đ	F5	245
B	42	66	o	6F	111	-	9C	156	É	C9	201	ö	F6	246
C	43	67	p	70	112		9D	157	Ž	CA	202	÷	F7	247
D	44	68	q	71	113	˘	9E	158	Ê	CB	203	ŭ	F8	248
E	45	69	r	72	114	˙	9F	159	Ĝ	CC	204	ł	F9	249
F	46	70	s	73	115		A0	160	Ķ	CD	205	ś	FA	250
G	47	71	t	74	116		A1	161	Ī	CE	206	ū	FB	251
H	48	72	u	75	117	‡	A2	162	Ĵ	CF	207	ü	FC	252
I	49	73	v	76	118	£	A3	163	Š	D0	208	ž	FD	253
J	4A	74	w	77	119	×	A4	164	Ń	D1	209	ž	FE	254
K	4B	75	x	78	120		A5	165	Ň	D2	210	·	FF	255
L	4C	76	y	79	121	ı	A6	166	Ó	D3	211			

Simplified Chinese Character Set

The TD devices support the Simplified Chinese character set (GB2312-80) for the People's Republic of China. The TD devices use Microsoft Windows encoding for this character set. The Windows encoding allows the TD devices to display the same characters as shown in the STEP 7-Micro/WIN Text Display wizard when you are using a Chinese emulator or a Chinese version of Microsoft Windows.

Chinese characters are represented in STEP 7-Micro/WIN by a pair of numbers which represent the encoding of the character in the GB2312-80 specification. The TD devices also use a pair of numbers to represent the Chinese character.

Notes for Using the Simplified Chinese Character Set

**Tip**

The Simplified Chinese character set requires a Chinese version of Windows or a Chinese emulator to properly display Chinese characters in the Text Display wizard. You must start the Chinese emulator before you start the STEP 7-Micro/WIN software.

On the TD 200C and the TD 200, you can display up to 20 single-byte characters per line of your message. Because Simplified Chinese uses double-byte characters, you can display up to 10 double-byte characters per line for a message in Chinese.

On the TD 100C, you can display up to 16 single-byte characters per line of your message. Because Simplified Chinese uses double-byte characters, you can display up to 8 double-byte characters per line for a message in Chinese.

The standard ASCII characters, such as numbers, punctuation, and upper and lowercase alphabet characters, are available when using the Simplified Chinese character set. Depending on your keyboard and/ or emulator, some of these standard characters may be formatted as single-byte characters instead of the double-byte characters like the Simplified Chinese characters. Standard ASCII characters and Chinese characters can be mixed on the TD display.

The Text Display wizard displays 8 or 10 double-byte character places for the text of a screen or alarm. You can fit any of the following combinations into a character position:

- 1 double-byte character
- 2 single-byte characters (standard ASCII)
- 1 single-byte character and 1 single-byte blank

You cannot fit one single-byte character plus one double-byte character in a character position.

The TD 100C does not support the entire Simplified Chinese character set. The most-used characters have been included in the TD 100C. See the *Simplified Chinese Characters Set* for a list of supported characters. Characters that are not supported by the TD 100C are displayed as a square (□).

**Tip**

The *Simplified Chinese Character Set* electronic file resides on the STEP 7-Micro/WIN documentation CD. This file shows the characters supported by the different TD devices.

Cyrillic Character Set

Table A-9 Cyrillic Character Set for the TD 100C, TD 200 and TD 200C

Char	Hex	Dec	Char	Hex	Dec	Char	Hex	Dec	Char	Hex	Dec	Char	Hex	Dec
	20	32	M	4D	77	z	7A	122	§	A7	167	Ф	D4	212
!	21	33	N	4E	78	{	7B	123	È	A8	168	Х	D5	213
"	22	34	O	4F	79		7C	124	©	A9	169	Ц	D6	214
#	23	35	P	50	80	}	7D	125	€	AA	170	Ч	D7	215
\$	24	36	Q	51	81	~	7E	126	«	AB	171	Ш	D8	216
%	25	37	R	52	82	Ђ	7F	127	¬	AC	172	Щ	D9	217
&	26	38	S	53	83	Ѓ	80	128	-	AD	173	Ъ	DA	218
'	27	39	T	54	84	Ѕ	81	129	®	AE	174	Ы	DB	219
(28	40	U	55	85	,	82	130	İ	AF	175	Ь	DC	220
)	29	41	V	56	86	ı	83	131	°	B0	176	Э	DD	221
*	2A	42	W	57	87	„	84	132	±	B1	177	Ю	DE	222
+	2B	43	X	58	88	…	85	133	ı	B2	178	Я	DF	223
,	2C	44	Y	59	89	†	86	134	ı	B3	179	а	E0	224
-	2D	45	Z	5A	90	‡	87	135	ı	B4	180	б	E1	225
.	2E	46	[5B	91	€	88	136	μ	B5	181	в	E2	226
/	2F	47	\	5C	92	‰	89	137	¶	B6	182	г	E3	227
0	30	48]	5D	93	Љ	8A	138	·	B7	183	д	E4	228
1	31	49	^	5E	94	<	8B	139	ë	B8	184	е	E5	229
2	32	50	_	5F	95	Њ	8C	140	№	B9	185	ж	E6	230
3	33	51	`	60	96	Ќ	8D	141	€	BA	186	з	E7	231
4	34	52	a	61	97	Ђ	8E	142	»	BB	187	и	E8	232
5	35	53	b	62	98	Џ	8F	143	j	BC	188	й	E9	233
6	36	54	c	63	99	ђ	90	144	S	BD	189	к	EA	234
7	37	55	d	64	100	‘	91	145	s	BE	190	л	EB	235
8	38	56	e	65	101	’	92	146	ı	BF	191	м	EC	236
9	39	57	f	66	102	“	93	147	A	C0	192	н	ED	237
:	3A	58	g	67	103	”	94	148	Б	C1	193	о	EE	238
;	3B	59	h	68	104	•	95	149	В	C2	194	п	EF	239
<	3C	60	I	69	105	–	96	150	Г	C3	195	р	F0	240
=	3D	61	j	6A	106	—	97	151	Д	C4	196	с	F1	241
>	3E	62	k	6B	107		98	152	Е	C5	197	т	F2	242
?	3F	63	l	6C	108	™	99	153	Ж	C6	198	у	F3	243
@	40	64	m	6D	109	љ	9A	154	З	C7	199	ф	F4	244
A	41	65	n	6E	110	>	9B	155	И	C8	200	х	F5	245
B	42	66	o	6F	111	њ	9C	156	Й	C9	201	ц	F6	246
C	43	67	p	70	112	ќ	9D	157	К	CA	202	ч	F7	247
D	44	68	q	71	113	ћ	9E	158	Л	CB	203	ш	F8	248
E	45	69	r	72	114	џ	9F	159	М	CC	204	щ	F9	249
F	46	70	s	73	115		A0	160	Н	CD	205	ъ	FA	250
G	47	71	t	74	116	ÿ	A1	161	О	CE	206	ы	FB	251
H	48	72	u	75	117	ÿ	A2	162	П	CF	207	ь	FC	252
I	49	73	v	76	118	Ј	A3	163	Р	D0	208	э	FD	253
J	4A	74	w	77	119	ѡ	A4	164	С	D1	209	ю	FE	254
K	4B	75	x	78	120	Ѓ	A5	165	Т	D2	210	я	FF	255
L	4C	76	y	79	121	ı	A6	166	У	D3	211			

Greek Character Set

Table A-10 Greek Character Set for the TD 100C, TD 200 and TD 200C

Char	Hex	Dec	Char	Hex	Dec	Char	Hex	Dec	Char	Hex	Dec	Char	Hex	Dec
	20	32	M	4D	77	z	7A	122	§	A7	167	Τ	D4	212
!	21	33	N	4E	78	{	7B	123	¨	A8	168	Υ	D5	213
"	22	34	O	4F	79		7C	124	©	A9	169	Φ	D6	214
#	23	35	P	50	80	}	7D	125	ª	AA	170	Χ	D7	215
\$	24	36	Q	51	81	~	7E	126	«	AB	171	Ψ	D8	216
%	25	37	R	52	82	€	7F	127	¬	AC	172	Ω	D9	217
&	26	38	S	53	83	€	80	128	-	AD	173	Ï	DA	218
'	27	39	T	54	84	,	81	129	®	AE	174	ÿ	DB	219
(28	40	U	55	85	,	82	130	—	AF	175	ά	DC	220
)	29	41	V	56	86	f	83	131	◦	B0	176	έ	DD	221
*	2A	42	W	57	87	„	84	132	±	B1	177	ή	DE	222
+	2B	43	X	58	88	…	85	133	²	B2	178	ί	DF	223
,	2C	44	Y	59	89	†	86	134	³	B3	179	Û	E0	224
-	2D	45	Z	5A	90	‡	87	135	´	B4	180	α	E1	225
.	2E	46	[5B	91		88	136	μ	B5	181	β	E2	226
/	2F	47	\	5C	92	‰	89	137	¶	B6	182	γ	E3	227
0	30	48]	5D	93		8A	138	·	B7	183	δ	E4	228
1	31	49	^	5E	94	<	8B	139	Έ	B8	184	ε	E5	229
2	32	50	~	5F	95		8C	140	Ή	B9	185	ζ	E6	230
3	33	51	`	60	96		8D	141	Ί	BA	186	η	E7	231
4	34	52	a	61	97		8E	142	»	BB	187	θ	E8	232
5	35	53	b	62	98		8F	143	Ό	BC	188	ι	E9	233
6	36	54	c	63	99		90	144	½	BD	189	κ	EA	234
7	37	55	d	64	100	´	91	145	Υ	BE	190	λ	EB	235
8	38	56	e	65	101	´	92	146	Ω	BF	191	μ	EC	236
9	39	57	f	66	102	“	93	147	ΐ	C0	192	ν	ED	237
:	3A	58	g	67	103	”	94	148	Α	C1	193	ξ	EE	238
;	3B	59	h	68	104	•	95	149	Β	C2	194	ο	EF	239
<	3C	60	I	69	105	—	96	150	Γ	C3	195	π	F0	240
=	3D	61	j	6A	106	—	97	151	Δ	C4	196	ρ	F1	241
>	3E	62	k	6B	107		98	152	Ε	C5	197	ς	F2	242
?	3F	63	l	6C	108	™	99	153	Ζ	C6	198	σ	F3	243
@	40	64	m	6D	109		9A	154	Η	C7	199	τ	F4	244
A	41	65	n	6E	110	>	9B	155	Θ	C8	200	υ	F5	245
B	42	66	o	6F	111		9C	156	Ι	C9	201	φ	F6	246
C	43	67	p	70	112		9D	157	Κ	CA	202	χ	F7	247
D	44	68	q	71	113		9E	158	Λ	CB	203	ψ	F8	248
E	45	69	r	72	114		9F	159	Μ	CC	204	ω	F9	249
F	46	70	s	73	115	..	A0	160	Ν	CD	205	ϊ	FA	250
G	47	71	t	74	116	ˆ	A1	161	Ξ	CE	206	Û	FB	251
H	48	72	u	75	117	À	A2	162	Ο	CF	207	ό	FC	252
I	49	73	v	76	118	£	A3	163	Π	D0	208	ύ	FD	253
J	4A	74	w	77	119	₣	A4	164	Ρ	D1	209	ώ	FE	254
K	4B	75	x	78	120	¥	A5	165		D2	210		FF	255
L	4C	76	y	79	121	¦	A6	166	Σ	D3	211			

Hebrew Character Set (TD 200C, TD 200 only)

Table A-11 Hebrew Character Set for the TD 200 and TD 200C

Char	Hex	Dec	Char	Hex	Dec	Char	Hex	Dec	Char	Hex	Dec	Char	Hex	Dec
	20	32	M	4D	77	z	7A	122	§	A7	167		D4	212
!	21	33	N	4E	78	{	7B	123	¨	A8	168	ן	D5	213
"	22	34	O	4F	79		7C	124	©	A9	169	”	D6	214
#	23	35	P	50	80	}	7D	125	×	AA	170	,	D7	215
\$	24	36	Q	51	81	~	7E	126	«	AB	171	”	D8	216
%	25	37	R	52	82	€	7F	127	¬	AC	172		D9	217
&	26	38	S	53	83	€	80	128	-	AD	173		DA	218
'	27	39	T	54	84		81	129	®	AE	174		DB	219
(28	40	U	55	85	,	82	130	™	AF	175		DC	220
)	29	41	V	56	86	f	83	131	°	B0	176		DD	221
*	2A	42	W	57	87	„	84	132	±	B1	177		DE	222
+	2B	43	X	58	88	...	85	133	²	B2	178		DF	223
,	2C	44	Y	59	89	†	86	134	³	B3	179	⋈	E0	224
-	2D	45	Z	5A	90	‡	87	135	´	B4	180	ב	E1	225
.	2E	46	[5B	91	^	88	136	µ	B5	181	ג	E2	226
/	2F	47	\	5C	92	%	89	137	¶	B6	182	ד	E3	227
0	30	48]	5D	93	‰	8A	138	·	B7	183	ה	E4	228
1	31	49	^	5E	94	<	8B	139	¸	B8	184	ו	E5	229
2	32	50	~	5F	95		8C	140	¹	B9	185	ז	E6	230
3	33	51	`	60	96		8D	141	º	BA	186	ח	E7	231
4	34	52	a	61	97		8E	142	»	BB	187	ט	E8	232
5	35	53	b	62	98		8F	143	¼	BC	188	י	E9	233
6	36	54	c	63	99		90	144	½	BD	189	ך	EA	234
7	37	55	d	64	100	,	91	145	¾	BE	190	ס	EB	235
8	38	56	e	65	101	'	92	146	¿	BF	191	ל	EC	236
9	39	57	f	66	102	“	93	147	.	C0	192	ם	ED	237
:	3A	58	g	67	103	”	94	148	..	C1	193	נ	EE	238
;	3B	59	h	68	104	•	95	149	...	C2	194	ן	EF	239
<	3C	60	i	69	105	-	96	150	...	C3	195	ו	F0	240
=	3D	61	j	6A	106	—	97	151	...	C4	196	ז	F1	241
>	3E	62	k	6B	107	~	98	152	...	C5	197	ח	F2	242
?	3F	63	l	6C	108	™	99	153	...	C6	198	ט	F3	243
@	40	64	m	6D	109		9A	154	...	C7	199	פ	F4	244
A	41	65	n	6E	110	>	9B	155	...	C8	200	ץ	F5	245
B	42	66	o	6F	111		9C	156	...	C9	201	כ	F6	246
C	43	67	p	70	112		9D	157	...	CA	202	ק	F7	247
D	44	68	q	71	113		9E	158	...	CB	203	ר	F8	248
E	45	69	r	72	114		9F	159	...	CC	204	ש	F9	249
F	46	70	s	73	115		A0	160	...	CD	205	ת	FA	250
G	47	71	t	74	116	i	A1	161	...	CE	206		FB	251
H	48	72	u	75	117	¢	A2	162	...	CF	207		FC	252
I	49	73	v	76	118	£	A3	163	...	D0	208		FD	253
J	4A	74	w	77	119	¤	A4	164	...	D1	209		FE	254
K	4B	75	x	78	120	¥	A5	165	...	D2	210		FF	255
L	4C	76	y	79	121	¦	A6	166	...	D3	211			

Latin 1 Character Set

Table A-12 Latin 1 Character Set for the TD 100C, TD 200 and TD 200C

Char	Hex	Dec	Char	Hex	Dec	Char	Hex	Dec	Char	Hex	Dec	Char	Hex	Dec
	20	32	M	4D	77	z	7A	122	§	A7	167	Ô	D4	212
!	21	33	N	4E	78	{	7B	123	¨	A8	168	Õ	D5	213
"	22	34	O	4F	79		7C	124	©	A9	169	Ö	D6	214
#	23	35	P	50	80	}	7D	125	ª	AA	170	×	D7	215
\$	24	36	Q	51	81	~	7E	126	«	AB	171	Ø	D8	216
%	25	37	R	52	82	€	80	128	¬	AC	172	Ù	D9	217
&	26	38	S	53	83	€	81	129	-	AD	173	Ú	DA	218
'	27	39	T	54	84	,	82	130	®	AE	174	Û	DB	219
(28	40	U	55	85	f	83	131	™	AF	175	Ü	DC	220
)	29	41	V	56	86	„	84	132	°	B0	176	Ý	DD	221
*	2A	42	W	57	87	…	85	133	±	B1	177	þ	DE	222
+	2B	43	X	58	88	†	86	134	²	B2	178	ß	DF	223
,	2C	44	Y	59	89	‡	87	135	³	B3	179	à	E0	224
-	2D	45	Z	5A	90	^	88	136	´	B4	180	á	E1	225
.	2E	46	[5B	91	%	89	137	µ	B5	181	â	E2	226
/	2F	47	\	5C	92	‰	8A	138	¶	B6	182	ã	E3	227
0	30	48]	5D	93	Š	8B	139	·	B7	183	ä	E4	228
1	31	49	^	5E	94	<	8C	140	¸	B8	184	å	E5	229
2	32	50	~	5F	95	œ	8D	141	¹	B9	185	æ	E6	230
3	33	51	`	60	96	ž	8E	142	º	BA	186	ç	E7	231
4	34	52	a	61	97	Ž	8F	143	»	BB	187	è	E8	232
5	35	53	b	62	98		90	144	¼	BC	188	é	E9	233
6	36	54	c	63	99	´	91	145	½	BD	189	ê	EA	234
7	37	55	d	64	100	¸	92	146	¾	BE	190	ë	EB	235
8	38	56	e	65	101	¸	93	147	¿	BF	191	ì	EC	236
9	39	57	f	66	102	“	94	148	À	C0	192	í	ED	237
:	3A	58	g	67	103	”	95	149	Á	C1	193	î	EE	238
;	3B	59	h	68	104	•	96	150	Â	C2	194	ï	EF	239
<	3C	60	I	69	105	–	97	151	Ã	C3	195	ð	F0	240
=	3D	61	j	6A	106	—	98	152	Ä	C4	196	ñ	F1	241
>	3E	62	k	6B	107	~	99	153	Å	C5	197	ò	F2	242
?	3F	63	l	6C	108	™	9A	154	Æ	C6	198	ó	F3	243
@	40	64	m	6D	109	š	9B	155	Ç	C7	199	ô	F4	244
A	41	65	n	6E	110	>	9C	156	È	C8	200	õ	F5	245
B	42	66	o	6F	111	œ	9D	157	É	C9	201	ö	F6	246
C	43	67	p	70	112		9E	158	Ê	CA	202	÷	F7	247
D	44	68	q	71	113	ž	9F	159	Ë	CB	203	ø	F8	248
E	45	69	r	72	114	ÿ	A0	160	Ì	CC	204	ù	F9	249
F	46	70	s	73	115		A1	161	Í	CD	205	ú	FA	250
G	47	71	t	74	116	ı	A2	162	Î	CE	206	û	FB	251
H	48	72	u	75	117	†	A3	163	Ï	CF	207	ü	FC	252
I	49	73	v	76	118	£	A4	164	Ð	D0	208	ý	FD	253
J	4A	74	w	77	119	¥	A5	165	Ñ	D1	209	þ	FE	254
K	4B	75	x	78	120	¥	A6	166	Ò	D2	210	ÿ	FF	255
L	4C	76	y	79	121	ı	A6	166	Ó	D3	211			

Latin 2 Character Set

Table A-13 Latin 2 Character Set for the TD 100C, TD 200 and TD 200C

Char	Hex	Dec	Char	Hex	Dec	Char	Hex	Dec	Char	Hex	Dec	Char	Hex	Dec
	20	32	M	4D	77	z	7A	122	§	A7	167	Ô	D4	212
!	21	33	N	4E	78	{	7B	123	¨	A8	168	Õ	D5	213
"	22	34	O	4F	79		7C	124	©	A9	169	Ö	D6	214
#	23	35	P	50	80	}	7D	125	§	AA	170	×	D7	215
\$	24	36	Q	51	81	~	7E	126	«	AB	171	Ř	D8	216
%	25	37	R	52	82	€	80	128	¬	AC	172	Û	D9	217
&	26	38	S	53	83	€	81	129	-	AD	173	Ú	DA	218
'	27	39	T	54	84	,	82	130	®	AE	174	Û	DB	219
(28	40	U	55	85	,	83	131	Ž	AF	175	Û	DC	220
)	29	41	V	56	86	„	84	132	°	B0	176	Ý	DD	221
*	2A	42	W	57	87	…	85	133	±	B1	177	Ť	DE	222
+	2B	43	X	58	88	†	86	134	˘	B2	178	ß	DF	223
,	2C	44	Y	59	89	‡	87	135	†	B3	179	ř	E0	224
-	2D	45	Z	5A	90	‰	88	136	˘	B4	180	á	E1	225
.	2E	46	[5B	91	‰	89	137	µ	B5	181	â	E2	226
/	2F	47	\	5C	92	Š	8A	138	¶	B6	182	ä	E3	227
0	30	48]	5D	93	Š	8B	139	·	B7	183	ä	E4	228
1	31	49	^	5E	94	‹	8C	140	˘	B8	184	ı	E5	229
2	32	50	_	5F	95	Š	8D	141	ą	B9	185	ć	E6	230
3	33	51	`	60	96	Ť	8E	142	š	BA	186	ç	E7	231
4	34	52	a	61	97	Ž	8F	143	»	BB	187	č	E8	232
5	35	53	b	62	98	Ž	90	144	Ĺ	BC	188	é	E9	233
6	36	54	c	63	99	˘	91	145	˘	BD	189	ę	EA	234
7	37	55	d	64	100	˘	92	146	ř	BE	190	ë	EB	235
8	38	56	e	65	101	˘	93	147	ž	BF	191	ě	EC	236
9	39	57	f	66	102	˘	94	148	Ř	C0	192	í	ED	237
:	3A	58	g	67	103	˘	95	149	Á	C1	193	î	EE	238
;	3B	59	h	68	104	˘	96	150	Â	C2	194	d'	EF	239
<	3C	60	I	69	105	˘	97	151	Ă	C3	195	ď	F0	240
=	3D	61	j	6A	106	˘	98	152	Ä	C4	196	ř	F1	241
>	3E	62	k	6B	107	˘	99	153	Ĺ	C5	197	ň	F2	242
?	3F	63	l	6C	108	˘	9A	154	Ć	C6	198	ó	F3	243
@	40	64	m	6D	109	˘	9B	155	Ç	C7	199	ô	F4	244
A	41	65	n	6E	110	˘	9C	156	Č	C8	200	õ	F5	245
B	42	66	o	6F	111	˘	9D	157	É	C9	201	ö	F6	246
C	43	67	p	70	112	˘	9E	158	Ę	CA	202	÷	F7	247
D	44	68	q	71	113	˘	9F	159	È	CB	203	ÿ	F8	248
E	45	69	r	72	114	˘	A0	160	Ë	CC	204	û	F9	249
F	46	70	s	73	115	˘	A1	161	Í	CD	205	ú	FA	250
G	47	71	t	74	116	˘	A2	162	Î	CE	206	Û	FB	251
H	48	72	u	75	117	˘	A3	163	Ď	CF	207	ü	FC	252
I	49	73	v	76	118	˘	A4	164	Đ	D0	208	ý	FD	253
J	4A	74	w	77	119	˘	A5	165	Ñ	D1	209	ţ	FE	254
K	4B	75	x	78	120	˘	A6	166	Ñ	D2	210	˘	FF	255
L	4C	76	y	79	121	˘	A6	166	Ó	D3	211			

Turkish (Latin 5) Character Set

Table A-14 Turkish Character Set for the TD 100C, TD 200 and TD 200C

Char	Hex	Dec	Char	Hex	Dec	Char	Hex	Dec	Char	Hex	Dec	Char	Hex	Dec
	20	32	M	4D	77	z	7A	122	§	A7	167	Ô	D4	212
!	21	33	N	4E	78	{	7B	123	¨	A8	168	Õ	D5	213
"	22	34	O	4F	79		7C	124	©	A9	169	Ö	D6	214
#	23	35	P	50	80	}	7D	125	ª	AA	170	×	D7	215
\$	24	36	Q	51	81	~	7E	126	«	AB	171	Ø	D8	216
%	25	37	R	52	82	€	7F	127	¬	AC	172	Ù	D9	217
&	26	38	S	53	83	€	80	128	-	AD	173	Ú	DA	218
'	27	39	T	54	84	,	81	129	®	AE	174	Û	DB	219
(28	40	U	55	85	,	82	130	AF	175	Ü	DC	220	
)	29	41	V	56	86	f	83	131	°	B0	176	İ	DD	221
*	2A	42	W	57	87	„	84	132	±	B1	177	Ş	DE	222
+	2B	43	X	58	88	…	85	133	²	B2	178	ß	DF	223
,	2C	44	Y	59	89	†	86	134	³	B3	179	à	E0	224
-	2D	45	Z	5A	90	‡	87	135	´	B4	180	á	E1	225
.	2E	46	[5B	91	^	88	136	µ	B5	181	â	E2	226
/	2F	47	\	5C	92	‰	89	137	¶	B6	182	ã	E3	227
0	30	48]	5D	93	Š	8A	138	·	B7	183	ä	E4	228
1	31	49	^	5E	94	<	8B	139	¸	B8	184	å	E5	229
2	32	50	¯	5F	95	œ	8C	140	¹	B9	185	æ	E6	230
3	33	51	`	60	96		8D	141	º	BA	186	ç	E7	231
4	34	52	a	61	97		8E	142	»	BB	187	è	E8	232
5	35	53	b	62	98		8F	143	¼	BC	188	é	E9	233
6	36	54	c	63	99		90	144	½	BD	189	ê	EA	234
7	37	55	d	64	100	,	91	145	¾	BE	190	ë	EB	235
8	38	56	e	65	101	,	92	146	¿	BF	191	ì	EC	236
9	39	57	f	66	102	“	93	147	À	C0	192	í	ED	237
:	3A	58	g	67	103	”	94	148	Á	C1	193	î	EE	238
;	3B	59	h	68	104	•	95	149	Â	C2	194	ï	EF	239
<	3C	60	i	69	105	—	96	150	Ã	C3	195	ğ	FO	240
=	3D	61	j	6A	106	—	97	151	Ä	C4	196	ñ	F1	241
>	3E	62	k	6B	107	~	98	152	Å	C5	197	ò	F2	242
?	3F	63	l	6C	108	™	99	153	Æ	C6	198	ó	F3	243
@	40	64	m	6D	109	š	9A	154	Ç	C7	199	ô	F4	244
A	41	65	n	6E	110	>	9B	155	È	C8	200	õ	F5	245
B	42	66	o	6F	111	œ	9C	156	É	C9	201	ö	F6	246
C	43	67	p	70	112		9D	157	Ê	CA	202	÷	F7	247
D	44	68	q	71	113		9E	158	Ë	CB	203	ø	F8	248
E	45	69	r	72	114	ÿ	9F	159	Ì	CC	204	ù	F9	249
F	46	70	s	73	115		A0	160	Í	CD	205	ú	FA	250
G	47	71	t	74	116	i	A1	161	Î	CE	206	û	FB	251
H	48	72	u	75	117	†	A2	162	Ï	CF	207	ü	FC	252
I	49	73	v	76	118	£	A3	163	Ğ	D0	208	ı	FD	253
J	4A	74	w	77	119	¤	A4	164	Ñ	D1	209	ş	FE	254
K	4B	75	x	78	120	¥	A5	165	Ò	D2	210	ý	FF	255
L	4C	76	y	79	121	ı	A6	166	Ó	D3	211			

Connecting Multiple Devices on a Network



You can connect multiple TD devices and S7-200 CPUs together on one communication network. The TD devices act as network masters and do not interfere with each other. You can designate the S7-200 CPUs to be either masters or slaves on the network.

In This Chapter

Communicating with Multiple CPUs	108
Determining the Distances, Transmission Rate, and Cable	108
Using Repeaters on the Network	109
Selecting the Network Cable	109
Biasing and Terminating the Network Cable	110
Building a TD/CPU Cable	110
Making a Cable That Supplies Power to the TD Device	111
Making a Cable That Does Not Supply Power to the TD 200 (TD 200C and TD 200 only)	111
CPU Grounding and Circuit Reference Point Guidelines for Using Isolated Circuits	112

Communicating with Multiple CPUs

Figure B-1 shows a typical network with two TD 200s and two S7-200 CPUs. Each TD 200 communicates to one of the CPUs. The addresses of each device are noted below the device in the figure. In this example:

- TD 200 Number 1 is configured to communicate to the S7-200 CPU at address 2 (CPU 1)
- TD 200 Number 2 is configured to communicate to the S7-200 CPU at address 3 (CPU 2)



Tip

You can connect multiple TD devices to a single S7-200 CPU. You can store separate parameter blocks for each TD device in different V memory locations in the CPU.

If you do not store separate parameter blocks for each TD device that is connected to the CPU, any of these TD devices can acknowledge the same messages and use function keys to initiate operations in the CPU.

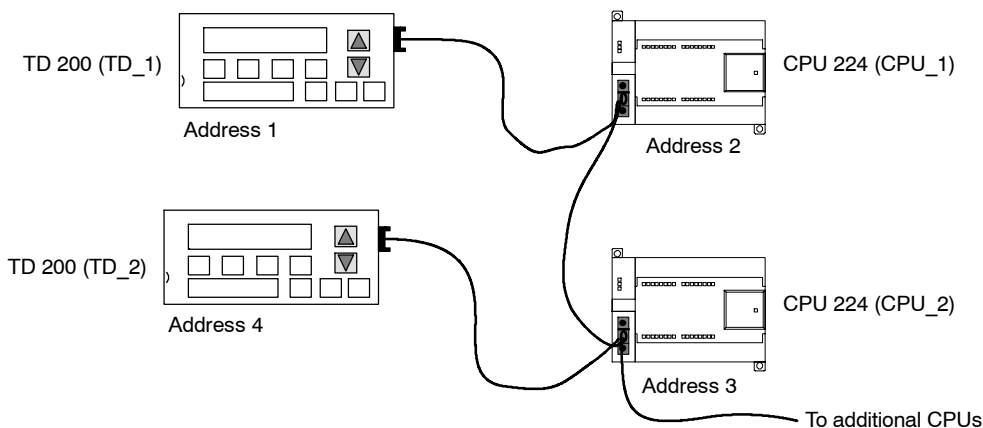

Figure B-1 Typical Multiple CPU Network



Tip

The display time slows as more TD devices are added to the network.

Network connectors are available from Siemens. Using these connectors allows you to isolate the CPUs from one another (the 24 VDC), but still allows you to power the TD device from the CPU. See the *SIMATIC S7-200 Programmable Controller System System Manual* for more information about using network connectors.

Determining the Distances, Transmission Rate, and Cable

As shown in Table B-1, the maximum length of a network segment is determined by two factors: isolation (using an RS-485 repeater) and baud rate.

Isolation is required when you connect devices at different ground potentials. Different ground potentials can exist when grounds are physically separated by a long distance. Even over short distances, load currents of heavy machinery can cause a difference in ground potential.

Table B-1 Maximum Length for a Network Cable

Baud Rate	Non-Isolated CPU Port ¹	CPU Port with Repeater or EM 277
9.6 kbaud to 187.5 kbaud	50 m	1,000 m

¹ The maximum distance allowed without using an isolator or repeater is 50 m. You measure this distance from the first node to the last node in the segment.

Using Repeaters on the Network

An RS-485 repeater provides bias and termination for the network segment. You can use a repeater for the following purposes:

- ❑ *To increase the length of a network:* Adding a repeater to your network allows you to extend the network another 50 m. If you connect two repeaters with no other nodes in between (as shown in Figure B-2), you can extend the network to the maximum cable length for the baud rate. You can use up to 9 repeaters in series on a network, but the total length of the network must not exceed 9600 m.
- ❑ *To add devices to a network:* Each segment can have a maximum of 32 devices connected up to 50 m at 9600 baud. Using a repeater allows you to add another segment (32 devices) to the network.
- ❑ *To electrically isolate different network segments:* Isolating the network improves the quality of the transmission by separating the network segments which might be at different ground potentials.

A repeater on your network counts as one of the nodes on a segment, even though it is not assigned a network address.

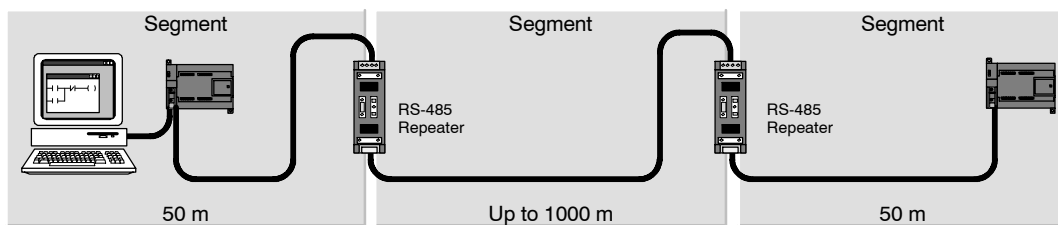

Figure B-2 Sample Network with Repeaters

Selecting the Network Cable

S7-200 networks use the RS-485 standard on twisted pair cables. Table B-2 lists the specifications for the network cable. You can connect up to 32 devices on a network segment.

Table B-2 General Specifications for Network Cable

Specifications	Description
Cable type	Shielded, twisted pair
Loop resistance	$\leq 115 \Omega/\text{km}$
Effective capacitance	30 pF/m
Nominal impedance	Approximately 135 Ω to 160 Ω (<i>frequency = 3 MHz to 20 MHz</i>)
Attenuation	0.9 dB/100 m (<i>frequency = 200 kHz</i>)
Cross-sectional core area	0.3 mm ² to 0.5 mm ²
Cable diameter	8 mm ± 0.5 mm

Biasing and Terminating the Network Cable

Siemens provides two types of network connectors that you can use to easily connect multiple devices to a network: a standard network connector and a connector that includes a programming port (which allows you to connect a programming station or an HMI device to the network without disturbing any existing network connections). The programming port connector passes all signals (including the power pins) from the S7-200 through to the programming port, which is especially useful for connecting devices that draw power from the S7-200 (such as a TD 200).

Both connectors have two sets of terminal screws to allow you to attach the incoming and outgoing network cables. Both connectors also have switches to bias and terminate the network selectively. Figure B-3 shows typical biasing and termination for the cable connectors.

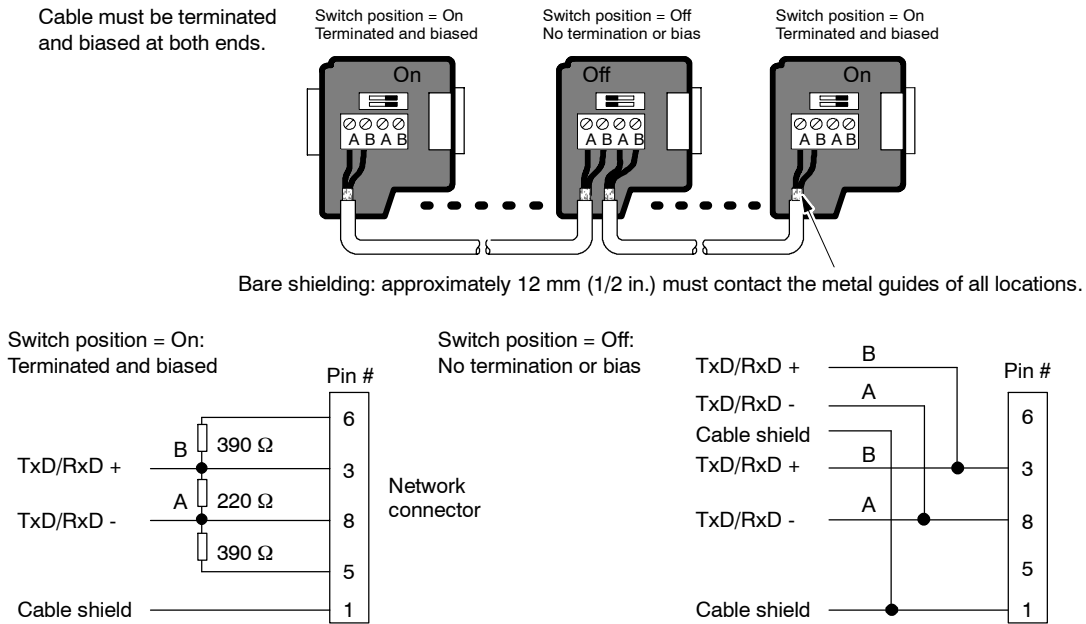

Figure B-3 Bias and Termination of the Network Cable

Building a TD/CPU Cable

The TD/CPU cable is used for connecting a display device to an S7-200 CPU. If you do not have a TD/CPU cable, refer to Figures B-4 and B-5 to create your own cable.

Making a Cable That Supplies Power to the TD Device



Caution

Connecting the 24 VDC power output (pin 7 of communication port) of multiple S7-200 CPUs may cause erratic operation of the I/O, which could potentially cause personal injury and/or property damage.

The 24 VDC power supply is also the sensor supply for the I/O. Interconnecting the output power supplies of multiple CPUs could possibly overload the sensor supply, which could cause the I/O to operate incorrectly.

When networking S7-200 CPUs, connect only the communication lines (pins 3, 5, and 8). You must **not** connect the power output (pin 7).



Tip

The TD 100C must use the TD/CPU cable shown in Figure B-4.

Figure B-4 shows you the pin-out of TD/CPU cable with power supplied to the TD 200. Use this option when you want the TD 200 to receive power from an S7-200 CPU.

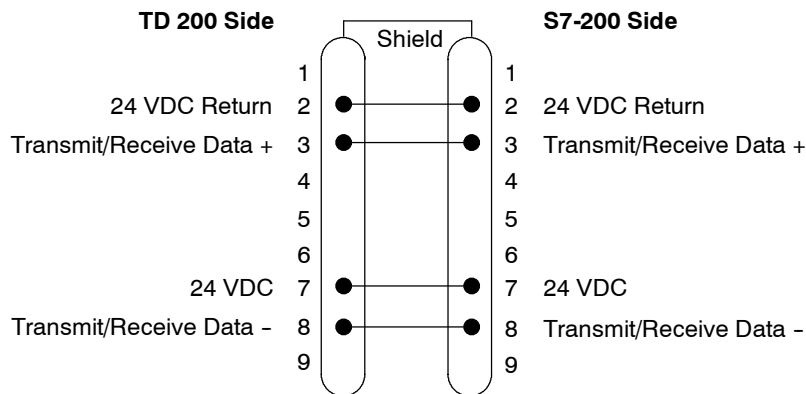

Figure B-4 TD/CPU Cable with Power Connections

Making a Cable That Does Not Supply Power to the TD 200 (TD 200C and TD 200 only)

Figure B-5 shows you the pin-out of a TD/CPU cable without power supplied to the TD 200. Use this option when you want the TD 200 to receive power from an external power supply. The maximum length for the cable is 1200 meters.

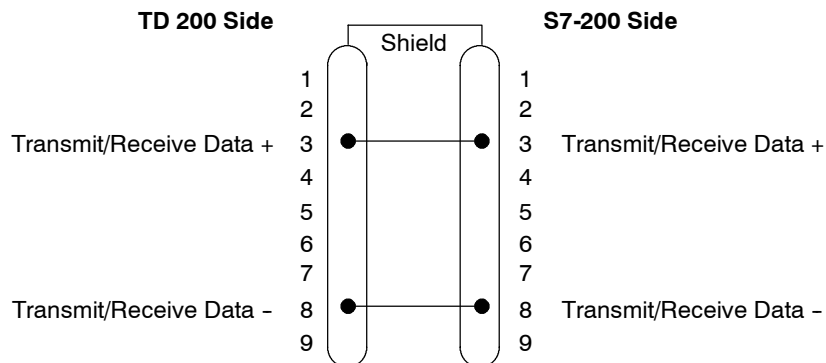

Figure B-5 TD/CPU Cable without Power Connections

CPU Grounding and Circuit Reference Point Guidelines for Using Isolated Circuits

The following items are CPU grounding and circuit guidelines for using isolated circuits:

- You should identify the reference point (0 voltage reference) for each circuit in the installation, and the points at which circuits with possibly different references can connect together. Such connections can result in unwanted current flows that can cause logic errors or can damage circuits. A common cause of different reference potentials is grounds that are physically separated by long distances. When devices with widely separated grounds are connected with a communication or sensor cable, unexpected currents can flow through the circuit created by the cable and the ground. Even over short distances, load currents of heavy machinery can cause differences in ground potential or can directly induce unwanted currents by electromagnetic induction. Power supplies that are improperly referenced with respect to each other can cause damaging currents to flow between their associated circuits.
- When you connect CPUs with different ground potentials to the same PPI network, you should use an isolated RS-485 repeater.
- S7-200 products include isolation boundaries at certain points to help prevent unwanted current flows in your installation. When you plan your installation, you should consider where these isolation boundaries are provided, and where they are not provided. You should also consider the isolation boundaries in associated power supplies and other equipment, and where all associated power supplies have their reference points.
- You should choose your ground reference points and use the isolation boundaries provided to interrupt unneeded circuit loops that could allow unwanted currents to flow. Remember to consider temporary connections which may introduce a new circuit reference, such as the connection of a programming device to the CPU.
- When locating grounds, you must also consider safety grounding requirements and the proper operation of protective interrupting devices.
- In most installations, you will have the best noise immunity if you connect the CPU sensor supply M terminal to ground.

The following descriptions are an introduction to general isolation characteristics of the S7-200 family, but some features may be different on specific products. Consult your product specifications in the appropriate manual for information about which circuits include isolation boundaries and the ratings of the boundaries. Isolation boundaries rated less than 1,500 VAC are designed as functional isolation only, and should not be depended on as safety boundaries.

- Logic circuit reference is the same as DC sensor supply M.
- Logic circuit reference is the same as the input power supply M on a CPU with DC power supply.
- CPU communication ports have the same reference as logic circuit.
- Analog inputs and outputs are not isolated from logic circuit. Analog inputs are full differential to provide low voltage common mode rejection.
- Logic circuit is isolated from ground to 500 VAC.
- DC digital inputs and outputs are isolated from logic circuit to 500 VAC.
- DC digital I/O groups are isolated from each other by 500 VAC.
- Relay outputs are isolated from logic circuit to 1,500 VAC.
- Relay output groups are isolated from each other by 1,500 VAC.
- AC power supply line and neutral are isolated from ground, the logic circuit, and all I/O to 1,500 VAC.

Troubleshooting

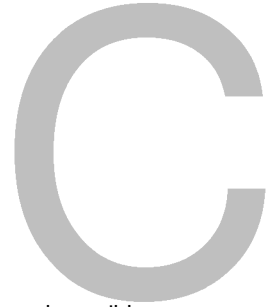

Refer to Table C-1 for a list of the problems that could occur with the TD device and possible causes and solutions.

Table C-1 Error Messages

Problem	Possible Cause	Possible Solution
NO PARAMETER BLOCK	The TD device could not find a parameter block in the programmable logic controller.	Configure a parameter block for the TD device using the Text Display wizard, and download it to the S7-200 Be sure the parameter block address in the TD device matches the actual address of the parameter block.
	The TD device found a parameter block in the programmable logic controller, but it contains errors	Be sure all fields are within range Be sure all addresses are valid for the S7-200 CPU
No CPU COMM	Address of the S7-200 CPU is incorrect	Correct the address error
	S7-200 CPU does not have power	Power up the CPU
	Cable problems	Check the cable connections
	Wrong baud rate configured	Correct the baud rate configuration
	Multiple CPUs at the same address	Remove other CPUs and retry
	May need network terminations	Refer to Appendix B
	Network too long or too many devices on network	Refer to Appendix B
HARDWARE ERROR	TD device is inoperable	The TD device could be defective Replace with a new TD device.
NETWORK ERROR TD device cannot establish a network connection or enter an existing network	Multiple masters with the same address.	Remove other masters and retry
	Cable problems	Check the cable connections
	Multiple CPUs at the same address	Remove the other CPUs and retry
CPU BUSY	Some other master has locked the S7-200 CPU by uploading or downloading a program to that CPU	Wait — The message disappears in a few seconds
CPU IN STOP MODE	RUN/STOP switch is in STOP	Put CPU in RUN mode
Display backlight is on, but no message is displayed	Program checksum failure	Defective hardware: Replace with a new TD device
User cannot access the TD system menus	The custom keypad does not contain the ESC and ENTER buttons.	To restore the standard TD keypad: <ol style="list-style-type: none"> 1. Power down the TD device 2. Press and hold the lower right corner (where ENTER key is located on the standard keypad) 3. Power up the TD device The default keypad is restored until the TD device is power cycled again.

Index

A

- Accessing screens and alarms, Button descriptions, 64
- Acknowledging an alarm, 72
 - Types of alarms, 55, 73
- Adhering a custom faceplate, 20, 38
- Alarms
 - Accessing the menus, 68
 - Acknowledging, 72
 - Alarm variables, 57
 - Button descriptions, 64
 - Configuring, 54–59
 - Default display mode, 7, 56, 71
 - Description, 7
 - Displaying, 72
 - Displaying alarms, 8
 - Displaying information, 66
 - Editing variables, 67, 75
 - Entering a password, 70
 - Parameter block, 7, 61
 - Priority, 72
 - Releasing a password, 70
 - TD Bit usage summary, 76
 - Types of alarms, 73
- Approvals, USA and Canada, for, 93
- Arabic character set, 97
- ATEX guidelines, 92

B

- Baltic character set, 98
- Bar graph character set, 96
- Baud rate, 83
 - Network, 108
- Biasing, Network cable, 110
- Brackets, mounting, TD 100C, 18
- Buttons
 - Accessing screens, alarms, and menus, 68
 - Default display mode, 71
 - Descriptions, 64
 - Displaying information, 66
 - Editing variables, 67, 75
 - Keypad Designer
 - Adding, 29
 - Button template, 32
 - Deleting, 30
 - Erasing, 30
 - Modifying, 29
 - Panel image, 33
 - Properties, 30–32
 - Reversing the panel image, 34
 - Momentary contact, 48
 - Set bit, 48
 - Template, 32
 - Valid buttons, 30

C

- Cable, 21, 90
 - Biasing, 110
 - Network, 108, 109
 - No power to TD 200, 111
 - TD 100C, 16
 - TD 100C order number, 90
 - TD/CPU Creating a pin-out, 110
 - Terminating, 110
 - To supply power to TD 200, 111
- CE Symbol, 92
- Certificates, Directives, Declarations, 92
- Changing
 - Language set, 81
 - Operating mode of S7–200 CPU, 85
 - Time and date, 80
- Character Set Error, troubleshooting, 113
- Character sets
 - Arabic, 97
 - Baltic, 98
 - Bar graph, 96
 - Chinese, Simplified, 99
 - Cyrillic, 100
 - Greek, 101
 - Hebrew, 102
 - Latin 1, 103
 - Latin 2, 104
 - Simplified Chinese, 60, 99
 - Standard TD, 94
 - Supported, 4
 - Turkish (Latin 5), 105
- Characters, special, ALT key combinations, 95
- Chinese (Simplified), Character set, 60, 99
- Communication, Multiple CPUs, 107
- Components
 - Faceplate overlay (TD 100C), 16
 - Faceplate overlay (TD 200C), 16
 - Gasket, 16
 - Label insert (TD 200), 16
 - Mounting brackets, 16
 - Spacers, 16
 - TD/CPU cable, 16
- Configuration
 - Alarms, 54–59
 - Types of alarms, 55
 - Default display mode, 56
 - Multiple CPUs, 107, 108
 - Multiple language sets, 59–61
 - Parameter block, 7, 61
 - Screens, 49–53
 - Alarm variables, 57
 - Screen text, 51
 - Screen variables, 51, 57
 - User menu, 50

- Subroutines, 61
- Task overview, 9–11, 40–42
- TD parameters, 42–47
 - Button functionality, 48
 - Device, 43
 - Enabling TD menu functions, 44
 - Keypad configuration file (*.td2, *.td1), 47
 - Language set (primary), 46
 - Password, 44
 - Update rate, 46
- Configuring the properties for the buttons, TD 100C, TD 200C keypad, 30–32
- Connecting the TD device, 21
- Contrast of the display area, 83
- CPU
 - Address, 83
 - Busy, troubleshooting, 113
 - Grounding and Circuit Point Guidelines, 112
 - Multiple CPU communication, 108
 - Not responding, troubleshooting, 113
- Creating a TD/CPU cable, 110
- Custom cable, 21
- Custom faceplate
 - Dimensions, 20
 - Installation procedures, 20, 38
 - Keypad configuration file (*.td2, *.td1), 27, 34, 47
 - Panel image, 33
 - Reversing the panel image, 34
 - Tasks for creating a custom faceplate, 27
 - Templates, 23
- Cyrillic character set, 100

D

- Date and Time for the TD device, 80
- Declaration of Conformity, 92
- Default display mode, 7, 71
- Diagnostic Menu, 82–87
 - Change Operating Mode, 85
 - Edit CPU memory, 86–88
 - Force I/O, 84
 - Make memory cartridge, 85
 - Setting up the TD device, 83
 - View messages, 84
- Dimensions
 - Faceplate (TD 100C), 20
 - Faceplate (TD 200C), 20
 - Label insert (TD 200), 19
 - TD device, 17
- Display backlight, troubleshooting, 113
- Displaying information, 66

E

- Editing the CPU memory, 86–88
- Editing variables, 67, 75
- Embedded String Variables, considerations, 53
- EMC Directive, 92
- Entering a password, 70
- Error messages, Status of the S7–200 CPU, 78
- Explosion protection guidelines, 92

- Exporting
 - Button Template, 32
 - Panel image, 33
- External power supply, 22

F

- Faceplate
 - Dimensions (custom faceplate), 20
 - Installing a custom faceplate, 20, 38
 - Keypad configuration file (*.td2, *.td1), 27, 34, 47
 - Material, 13, 35–38
 - Material Order number, 13
 - Order number, 13
 - Panel image, 33
 - Reversing the panel image, 34
 - Standard TD keypad, 6, 64
 - Tasks for creating a custom faceplate, 27
 - Template file (A4), 12, 26
 - Templates, 23
- Features, 3
 - Comparing TD devices, 5
 - Order number
 - Faceplate material, 13, 90
 - TD 100C, 90
 - TD 200, 90
 - TD 200C, 90
- Floating-point numbers, 75
- FM Approval, 93
- Font size, TD 100C, 47
- Forcing I/O, 84

G

- Gap factor, 83
- Gasket, 16, 18
- Graphics application
 - Button template, 32
 - Panel image, 33
- Greek character set, 101
- Guidelines
 - CPU grounding and circuit reference point, 112
 - Setup, 92

H

- Hardware
 - Order number
 - Faceplate material, 13, 90
 - TD 100C, 90
 - TD 200, 90
 - TD 200C, 90
 - Setting up the TD device, 83
 - Specification, 90
 - Task overview, 9–11
- Hardware Error, troubleshooting, 113
- Hebrew character set, 102
- Hierarchy of menus, 68
- Highest station, 83

I

- Importing, Panel image, 33
- Installation
 - Components, 16
 - Connecting a TD 100C, 23
 - Connecting a TD 200C, 23
 - Custom cable, 21
 - Dimensions
 - Custom faceplate, 20
 - Label insert, 19
 - TD device, 17, 18
 - Installing a custom faceplate, 20, 38
 - Mounting a TD device, 17–19
 - Mounting brackets, 18
 - Order number
 - Faceplate material, 13
 - Faceplate material, 90
 - TD 100C, 90
 - TD 200, 90
 - TD 200C, 90
 - Power (TD/CPU cable), 22
 - Power supply, 22
 - Procedures and guidelines, 15–23
 - Spacers, 17
 - Task overview, 9–11
 - TD/CPU cable, 21
- International characters, 95
- Isolated circuits, Guidelines, 112
- Isolation
 - Characteristics of S7-200 , 112
 - Network, 108

K

- Keypad
 - Creating a custom keypad, 12, 26
 - Order number for faceplate material, 13
 - Panel image, 33
 - Restoring standard, 82, 113
 - Restoring standard TD, 23
 - Reversing the panel image, 34
 - Standard TD, 6, 64
- Keypad configuration file (*.td2, *.td1), 27, 28, 34, 47
- Keypad Designer
 - Buttons
 - Adding, 29
 - Button template, 32
 - Deleting, 30
 - Erasing, 30
 - Modifying, 29–31
 - Moving, 29
 - Panel image, 33
 - Properties, 30–32
 - Reversing the panel image, 34
 - Configuration file (Text Display wizard), 47
 - Dimensions (custom faceplate), 20
 - Faceplate template file, 12, 26
 - File types, 28
 - Installing a custom faceplate, 20, 38
 - Keypad configuration file (*.td2, *.td1), 27, 34, 47

- Options, 28
- Order number for faceplate material, 13
- Overview, 12, 26
- Printer requirements, 13
- Saving, 34
- Starting the application, 28
- Tasks for creating a custom faceplate, 27
- Templates, 23
- Text Display wizard, 40–42
- Tools (options), 28

Keys

- Accessing screens, alarms, and menus, 68
- Button descriptions, 64
- Button template, 32
- Displaying information, 66
- Editing variables, 67, 75
- Keypad Designer
 - Adding buttons, 29
 - Deleting buttons, 30
 - Erasing buttons, 30
 - Modifying buttons, 29
 - Properties, 30–32
- Panel image, 33
- Reversing the panel image, 34

L

- Label insert (TD 200)
 - Dimensions, 19
 - Modifying, 19
- Language set
 - Multiple, 59–61
 - Primary, 46
 - Switching languages, 81
- Laser printer requirements, 13
- Latin 1 character set, 103
- Latin 2 character set, 104

M

- Making, Cable to supply power to TD 200, 111
- Making a cable, No power to TD 200, 111
- Memory cartridge, 85
- Menus
 - Accessing the menus, 68
 - Default display mode, 71
 - Diagnostic Menu, 82–87
 - Display Alarms, 72
 - Displaying information, 66
 - Editing variables, 67, 75
 - Hierarchy, 68
 - Operator Menu, 78–81
- Messages
 - Accessing screens, alarms, and menus, 68
 - Displaying information, 66
 - Editing variables, 67, 75
- Momentary contact, Buttons, 48
- Mounting a TD device, 17–19
 - Spacers, 17
- Multiple language sets, 59–61

N

Network

- Address, 83
- Baud rate, 108
- Biasing cable, 110
- Cable, 108, 109
- Calculating distances, 108
- Connectors, 108
- Isolation, 108
- Repeaters, 109
- Terminating cable, 110
- Transmission rate, 108
- Typical multiple CPU , 108
- Network Error, troubleshooting, 113
- No Parameter Block, troubleshooting, 113

O

Operation

- Accessing screens, alarms, and menus, 68
- Button descriptions, 64
- Changing the language set, 81
- Changing the operating mode of the S7-200 CPU, 85
- Displaying information, 66
- Editing the CPU memory, 86–88
- Editing variables, 67, 75
- Forcing I/O, 84
- Making a memory cartridge, 85
- Overview (screens and alarms), 8
- Reviewing the configured messages, 84
- Setting the time and date, 80
- Setting up the TD device, 83
- Types of alarms, 73
- Viewing the status of the S7-200 CPU, 78
- Operator Menu, 78–81
 - Changing the language set, 81
 - Setting the Time and Date, 80
 - View Status of the S7-200 CPU
 - Error messages, 78
 - Firmware version, 78

Order number

- Faceplate material, 13, 90
- TD 100C, 90
- TD 200, 90
- TD 200C, 90
- TD/CPU cable, 90

P

- Panel image, 33
 - Reversing for print, 34
- Parameter block, 7, 9
 - Configuring the address in the TD device, 83
 - V memory address, 61
- Password
 - Entering, 70
 - Releasing, 70
- Pin-out, TD/CPU cable, 110
- Power supply, 22

- Primary language set, 46
- Printer requirements, 13
- Printing a custom faceplate, Creating a custom faceplate, 27
- Printing multiple faceplates, 13, 35–38
 - Template file, 12, 26
- Printing the faceplate, Reversing the panel image, 34
- Priority of alarms, 72
- Product overview, 1–10
 - Backwards compatible, 15
 - Character sets, 4
 - Comparison TD devices, 5
 - Components, 16
 - Creating a custom keypad, 12, 26
 - Description, 2
 - Features, 3
 - Order number
 - Faceplate material, 13, 90
 - TD 100C, 90
 - TD 200, 90
 - TD 200C, 90
 - TD/CPU cable, 90
 - Printer requirements, 13
 - Standard TD keypads, 6, 64
 - Task overview, 9
- PROFIBUS-DP network
 - Cable specifications, 108
 - Repeaters, 109
- Properties of buttons (TD 100C, TD 200C), 30–32

R

- Real numbers, 75
- Releasing a password, 70
- Repeaters, Network, 109
- Restoring standard TD keypad, 23, 82, 113
- Reversing the panel image, 34
- Reviewing the configured messages, 84
- RS-485 standard, 109

S

- S7-200 CPU
 - Changing the operating mode, 85
 - Editing the CPU memory, 86–88
 - Error messages, 78
 - Firmware version, 78
 - General isolation characteristics, 112
 - Making a memory cartridge, 85
 - Model number, 78
 - Parameter block, 7
 - Supplying power to the TD device, 22
- Screens
 - Accessing the menus, 68
 - Button descriptions, 64
 - Configuring, 49–53
 - Default display mode, 7, 56, 71
 - Displaying information, 66
 - Displaying screens, 8
 - Editing variables, 67, 75

- Entering a password, 70
 - Overview, 7
 - Parameter block, 7, 61
 - Releasing a password, 70
 - Screen variables, 51
 - Text message, 51
 - User menu, 50
 - Setting the time and date for the TD device, 80
 - Setup Guidelines, 92
 - Simplified Chinese, Character set, 60
 - Simplified Chinese character Set, 99
 - Simplified Chinese character set, 99
 - Spacers, 17
 - Special characters, 95
 - Specifications, 90–92
 - Standard TD
 - Character set, 94
 - Keypad, 23, 64
 - Restoring keypad, 23
 - Keypads, 6
 - Restoring keypad, 82
 - Restoring TD keypad, 113
 - STEP 7-Micro/WIN
 - Keypad configuration file (*.td2, *.td1), 27, 34, 47
 - Keypad Designer, 3
 - Starting the Keypad Designer, 28
 - Subroutines, 61
 - Task overview, 9–11
 - Text Display wizard, 3
 - Alarm variables, 57
 - Alarms, 54–59
 - Default display mode, 56
 - Parameter block, 61
 - Screen text, 51
 - Screen variables, 51
 - Screens, 49–53
 - User menu, 50
 - STR_CPY, using to create strings, 53
 - String variables, Embedded, 53
 - Summary, TD Bit Usage, 76
 - Switching the language set, 81
- ## T
- TD 100C
 - Accessing screens, alarms, and menus, 68
 - Alarms, 7
 - Cable, 90
 - Character sets, 4
 - Comparing TD devices, 5
 - Compatibility with other TDs, 15
 - Components, 16
 - Configuration tasks, 40–42
 - Contrast of the display, 83
 - Creating a custom keypad, 12, 26
 - Default display mode, 71
 - Description, 2
 - Dimensions, TD 100C, 18
 - Displaying alarms, 8
 - Displaying information, 66
 - Displaying screens, 8
 - Editing variables, 67, 75
 - Entering a password, 70
 - Establishing a connection, 23
 - Features, 3, 5
 - Font size, 47
 - Installation procedures, 15–23
 - Installing a custom faceplate, 20, 38
 - Keypad configuration file (*.td1), 27, 34, 47
 - Mounting brackets, 16
 - Order number
 - Faceplate material, 13, 90
 - TD 100C, 90
 - Parameter block, 7
 - Printer requirements, 13
 - Product overview, 1–13
 - Releasing a password, 70
 - Screens, 7
 - Set time and date, 80
 - Setup, 83
 - Specifications, 90
 - Standard configuration, 23
 - Standard TD keypad, 6, 64
 - Standard TD template, 23
 - Supplying power, 22
 - Task overview, 9–11
 - Tasks for creating a custom faceplate, 27
 - TD parameters, 42
 - Button functionality, 48
 - Device, 43
 - Enabling TD menu functions, 44
 - Keypad configuration file (*.td1), 47
 - Language set (primary), 46
 - Password, 44
 - Update rate, 46
 - TD/CPU cable, 21
 - Templates, 23
 - Types of alarms, 55, 73
- TD 200
 - Accessing screens, alarms, and menus, 68
 - Alarms, 7
 - Backwards compatible, 15
 - Changing the language set, 81
 - Character sets, 4
 - Comparing TD devices, 5
 - Components, 16
 - Configuration tasks, 40–42
 - Contrast of the display, 83
 - Default display mode, 71
 - Description, 2
 - Dimensions
 - Label insert, 19
 - TD 200, 17
 - Displaying alarms, 8
 - Displaying information, 66
 - Displaying screens, 8
 - Editing variables, 67, 75
 - Entering a password, 70
 - Features, 3, 5
 - Forcing I/O, 84
 - Installation procedures, 15–23
 - Modifying the label insert, 19
 - Mounting instructions, 17–19
 - Multiple language sets, 59–61
 - Order number, TD 200, 90

- Parameter block, 7
- Product overview, 1–10
- Releasing a password, 70
- Reviewing the configured messages, 84
- Screens, 7
- Set time and date, 80
- Setup, 83
- Spacers, 17
- Specification, 90–92
- Standard TD keypad, 6, 64
- Supplying power, 22
- Task overview, 9–11
- TD parameters, 42–47
 - Button functionality, 48
 - Device, 43
 - Enabling TD menu functions, 44
 - Keypad configuration file (*.td2), 47
 - Language set (primary), 46
 - Password, 44
 - Update rate, 46
- TD/CPU cable, 21
- Types of alarms, 55, 73
- TD 200C
 - Accessing screens, alarms, and menus, 68
 - Alarms, 7
 - Backwards compatible, 15
 - Changing the language set, 81
 - Changing the operating mode of the S7-200 CPU, 85
 - Character sets, 4
 - Comparing TD devices, 5
 - Components, 16
 - Configuration tasks, 40–42
 - Contrast of the display, 83
 - Creating a custom keypad, 12, 26
 - Default display mode, 71
 - Description, 2
 - Dimensions, TD 200C, 17
 - Displaying alarms, 8
 - Displaying information, 66
 - Displaying screens, 8
 - Editing the CPU memory, 86–88
 - Editing variables, 67, 75
 - Entering a password, 70
 - Establishing a connection, 23
 - Features, 3, 5
 - Forcing I/O, 84
 - Installation procedures, 15–23
 - Installing a custom faceplate, 20, 38
 - Keypad configuration file (*.td2), 27, 34, 47
 - Making a memory cartridge, 85
 - Mounting instructions, 17–19
 - Multiple Language sets, 59–61
 - Order number
 - Faceplate material, 13, 90
 - TD 200C, 90
 - Parameter block, 7
 - Printer requirements, 13
 - Product overview, 1–13
 - Releasing a password, 70
 - Reviewing the configured messages, 84
 - Screens, 7
 - Set time and date, 80
 - Setup, 83
 - Spacers, 17
 - Specifications, 90
 - Standard configuration, 23
 - Standard TD faceplate, 23
 - Standard TD keypad, 6, 64
 - Supplying power, 22
 - Task overview, 9–11
 - Tasks for creating a custom faceplate, 27
 - TD parameters, 42–47
 - Button functionality, 48
 - Device, 43
 - Enabling TD menu functions, 44
 - Keypad configuration file (*.td2), 47
 - Language set (primary), 46
 - Password, 44
 - Update rate, 46
 - TD/CPU cable, 21
 - Templates, 23
 - Types of alarms, 55, 73
- TD Bit Usage summary, 76
- TD/CPU cable, 16, 21
 - Creating a pin-out, 110
- Template for printing multiple faceplates, 12, 26
 - Printer requirements, 13
- Templates, Standard TD keypad, 23
- Terminating, Network cable, 110
- Text Display wizard
 - Alarm variables, 57
 - Alarms, 54–59
 - Default display mode, 56
 - Multiple language sets, 59–61
 - Parameter block, 61
 - Screen text, 51
 - Screen variables, 51
 - Screens, 49–53
 - Subroutines, 61
 - Task overview, 40–42
 - TD parameters, 42–47
 - Button functionality, 48
 - Device, 43
 - Enabling TD menu functions, 44
 - Keypad configuration file (*.td2, *.td1), 47
 - Language set (primary), 46
 - Password, 44
 - Update rate, 46
 - User menu, 50
- Time and Date for the TD device, 80
- Transmission rate, Network, 108
- Troubleshooting, TD 200, 113
- Turkish (Latin 5) character set, 105
- Types of alarms, 55, 73

U

- Unforcing I/O, 84

V

- V memory address for the parameter block, 61
- Valid buttons, Description, 30
- Variables, Editing values, 67, 75
- View status of the S7-200 CPU
 - Error messages, 78
 - Firmware version, 78
- Viewing the configured messages, 84

W

- Wizard
 - Configuring the alarm variables, 57
 - Configuring the alarms, 54–59
 - Configuring the screen text, 51
 - Configuring the screen variables, 51
 - Configuring the screens, 49–53
 - Configuring the user menu, 50
 - Default display mode, 56
 - Parameter block, 61
- Wizard (TD configuration)
 - Multiple language sets, 59–61
 - Task overview, 40–42
 - TD parameters, 42–47
 - Button functionality, 48
 - Device, 43
 - Enabling TD menu functions, 44
 - Keypad configuration file (*.td2, *.td1), 47
 - Language set (primary), 46
 - Password, 44
 - Update rate, 46

To

SIEMENS ENERGY & AUTOMATION INC
ATTN: TECHNICAL COMMUNICATIONS
ONE INTERNET PLAZA
PO BOX 4991
JOHNSON CITY TN USA 37602-4991

From

Name: -----
Job Title: -----
Company Name: -----
Street: -----
City and State: -----
Country: -----
Telephone: -----

Please check any industry that applies to you:

- | | |
|---|---|
| <input type="checkbox"/> Automotive | <input type="checkbox"/> Pharmaceutical |
| <input type="checkbox"/> Chemical | <input type="checkbox"/> Plastic |
| <input type="checkbox"/> Electrical Machinery | <input type="checkbox"/> Pulp and Paper |
| <input type="checkbox"/> Food | <input type="checkbox"/> Textiles |
| <input type="checkbox"/> Instrument and Control | <input type="checkbox"/> Transportation |
| <input type="checkbox"/> Non-electrical Machinery | <input type="checkbox"/> Other _____ |
| <input type="checkbox"/> Petrochemical | |

